

READ AND SAVE THESE INSTRUCTIONS

OPERATION MANUAL

High pressure water treatment system
Condair Vita Power

Thank you for choosing Condair

Installation date (MM/DD/YYYY):

Commissioning date (MM/DD/YYYY):

Location ref.:

Model:

Serial number:

Proprietary Notice

This document and the information disclosed herein are proprietary data of Condair Group AG. Neither this document, nor the information contained herein shall be reproduced, used, or disclosed to others without the written authorization of Condair Group AG, except to the extent required for installation or maintenance of recipient's equipment.

Liability Notice

Condair Group AG does not accept any liability due to incorrect installation or operation of the equipment or due to the use of parts/components/equipment that are not authorized by Condair Group AG.

Copyright Notice

© Condair Group AG All rights reserved.

Technical modifications reserved

Contents

1	Introduction	5
1.1	Read me first!	5
1.2	Notes on the operation manual	5
2	For your safety	7
3	Product overview	10
3.1	Model overview	10
3.2	System overview Condair Vita Power RO-DI-CO-UV-HP	11
3.3	System overview Condair Vita Power RO-UV-HP	12
3.4	System overview Condair Vita Power UV-HP	13
3.5	System overview Condair Vita Power RO	14
4	Operation	15
4.1	First-time commissioning	15
4.2	Display and operating elements	16
4.3	Recommissioning after interruption of operation	17
4.4	Notes on operation	17
4.4.1	Important notes on operation	17
4.4.2	Remote operating and fault indication	18
4.4.3	Regular checks during operation	18
4.4.3.1	Check the Condair Vita Power water treatment system	18
4.4.3.2	Check the salt level of the optional water softener	18
4.5	Manual functions	19
4.5.1	Refreshing the reverse osmosis	19
4.5.2	Flushing the reverse osmosis	20
4.5.3	Flushing the high pressure system	21
4.5.4	Refreshing the entire system	22
4.6	Temporary decommissioning	23
5	Operating the Condair Vita Power control software	24
5.1	Home screen	24
5.1.1	Device status indication field	25
5.1.2	Operating parameter field	26
5.1.3	Area control field	26
5.2	Information functions in the "Help" Menu	27
5.2.1	Assessing the "Help" menu	27
5.2.2	Query operating states in the "About" submenu	27
5.2.2.1	Query software versions in the "About > Software Version" submenu	28
5.2.2.2	Query reverse osmosis unit information in the "About > RO" submenu	28
5.2.2.3	Query Deionizing and CO ₂ unit information in the "About > DI + CO ₂ " submenu	28
5.2.2.4	Query high pressure unit information in the "About > HP" submenu	29
5.2.2.5	Query water softener information in the "About > Water softener" submenu	29
5.2.3	Quick access to setting parameters in the "Quick Access" submenu	30
5.3	Configuration	31
5.3.1	Settings and features in the "General" submenu	31
5.3.1.1	Accessing the "General" submenu	31
5.3.1.2	Determine language and system of units in the "Region" submenu	31
5.3.1.3	Date and time settings in the "Date & Time" submenu	32
5.3.1.4	Read in parameter settings in the "Backup" submenu	32
5.3.1.5	Activate/Deactivate password protection in the "Password Settings" submenu	33
5.3.1.6	Set the brightness of the touchscreen and the LED in the "Brightness" submenu	33

5.3.2	Settings and features in the "Maintenance" submenu	34
5.3.2.1	Accessing the "Maintenance" submenu	34
5.3.2.2	Start the wizard for replacing the micro particle filter(s)	34
5.3.2.3	Start the wizard for replacing the deionizing cartridges	35
5.3.2.4	Functions in the "Error & Warning" submenu	35
5.3.2.5	Software update in the "Update" submenu	36
5.3.2.6	Load and export the error log file in the "Error Analyzer" submenu	37
5.3.2.7	Start operating data recording in the "USB Data Logger" submenu	37
5.3.3	Settings and features in the "Features"	38
5.3.3.1	Accessing the "Features" submenu	38
5.3.3.2	Defining the comfort mode time in the "Comfort Mode" submenu	38
5.3.4	Settings and features in the "Controls" submenu	39
5.3.4.1	Accessing the "Controls" submenu	39
5.3.4.2	Control settings in the "Configure all areas" submenu	40
5.3.4.3	Control settings in the "Areas xx" submenus	41
5.3.5	Communication settings in the "Network" submenu	42
5.3.5.1	Accessing the "Network" submenu	42
5.3.5.2	Settings in the "IP Settings" submenu	43
5.3.5.3	Settings in the "IoT Settings" submenu	44
5.3.5.4	Settings in the "Modbus Settings" submenu	44
5.3.5.5	Settings in the "BACnet Settings" submenu	45
6	Maintenance	46
6.1	Important notes on maintenance	46
6.2	Maintenance intervals	47
6.3	Maintenance list	47
6.4	Maintenance work	48
6.4.1	Replacing the micro particle filter(s)	48
6.4.2	Replace deionizing cartridge	48
6.4.3	Replacing the CO ₂ compressed gas cylinder	49
6.4.4	Performing software updates	51
7	Fault elimination	52
7.1	Important notes on fault elimination	52
7.2	Fault indication	53
7.3	Malfunction lists	54
7.3.1	Malfunction list System Master	54
7.3.2	Malfunction list external control unit	59
7.4	Resetting malfunction indication	60

1 Introduction

1.1 Read me first!

We thank you for having purchased the **Condair Vita Power high pressure water treatment system** (Condair Vita Power for short).

The Condair Vita Power incorporates the latest technical advances and meets all recognized safety standards. Nevertheless, improper use of the Condair Vita Power may result in danger to the user or third parties and/or damage to property.

To ensure a safe, proper, and economical operation of the Condair Vita Power, please observe and comply with all information and safety instructions contained in the present documentation as well as in the separate documentations of the components used together with the Condair Vita Power.

If you have questions after reading this documentation, please contact your Condair representative. He will be glad to assist you.

1.2 Notes on the operation manual

Limitation

The subject of this operation manual is the Condair Vita Power in its different versions. The various options and accessories are only described insofar as is necessary for proper installation of the equipment. Further information on options and accessories can be obtained in the respective instructions.

This operation manual is restricted to the **commissioning, operation, maintenance and troubleshooting** of the Condair Vita Power and is meant for **well-trained personnel being sufficiently qualified for their respective work.**

This operation manual is supplemented by various separate items of documentation (operation manual, spare parts list, etc.), which are included in the delivery as well. Where necessary, appropriate cross-references are made to these publications in the operation manual.

Symbols used in this manual



CAUTION!

The catchword "CAUTION" used in conjunction with the general caution symbol designates notes in this manual that, if neglected, may cause **damage and/or malfunction of the unit or other material assets**.



WARNING!

The catchword "WARNING" used in conjunction with the general caution symbol designates safety and danger notes in this manual that, if neglected, may cause **injury to persons**.



DANGER!

The catchword "DANGER" used in conjunction with the general caution symbol designates safety and danger notes in this manual that, if neglected, may lead to **severe injury or even death of persons**.

Safekeeping

Please safeguard this operation manual in a safe place, where it can be immediately accessed. If the equipment changes hands, this operation manual must be passed on to the new operator.

If the operation manual gets mislaid, please contact your Condair representative.

Language versions

This operation manual is available in various languages. Please contact your Condair representative for information.

2 For your safety

General

Every person working with the Condair Vita Power must have read and understood the Condair Vita Power installation manual and the Condair Vita Power operation manual before carrying out any work. Knowing and understanding the contents of these manuals is a basic requirement for protecting personnel against any kind of danger, to prevent faulty operation, and to operate the Condair Vita Power safely and correctly.

All icons, signs and markings applied to the components of the Condair Vita Power must be observed and kept in readable state.

Qualification of personnel

All work described in the Condair Vita Power installation manual and operation manual **may only be carried out by specialists who are well trained and adequately qualified and are authorized by the customer.**

For safety and warranty reasons any action beyond the scope of this manual must be carried out only by trained service personnel authorized by Condair.

For VDI-certified systems, the personnel must meet the following qualifications:

- For general installation, maintenance and inspection work:
Completed training according to **VDI 6022 Sheet 6, Qualification category B**
- For hygiene-relevant work during planning, installation, commissioning, operation and maintenance as well as for hygiene inspections:
Completed training according to **VDI 6022 Sheet 6, Qualification category A**

It is assumed that all persons working with the Condair Vita Power are familiar and comply with the appropriate regulations on work safety and the prevention of accidents.

Intended use

The Condair Vita Power high pressure water treatment system is intended **to be used exclusively for pure water or ultra pure water production for the supply of Condair isothermal or adiabatic humidifiers within the operating conditions as specified.** Any other use without the written consent of Condair, is considered as not conforming with the intended purpose and may lead to the Condair Vita Power becoming dangerous and will void any warranty.

Operation of the equipment in the intended manner requires **that all the information contained in Condair Vita Power installation manual and the Condair Vita Power operation manual are observed (in particular the safety instructions).**

Danger that may arise from the Condair Vita Power water treatment system



DANGER!
Risk of electric shock!

The Condair Vita Power is mains powered. Live parts may be exposed when components of the system are opened. Touching live parts may cause severe injury or danger to life.

Prevention: Before carrying out any work on the components of the **Condair Vita Power** take the system out of operation as described in [Section 4.6](#) and secure the system against inadvertent power-up.



DANGER!
Health risk because of inadequate hygiene!

Inadequately operated and/or poorly maintained pure water systems may endanger health.

Prevention: The Condair Vita Power system must strictly be operated and maintained in accordance with this manual.



WARNING!

To prevent water stagnation and microbial contamination, the power supply to the Condair Vita Power should be left switched on. If the system is switched off for more than 72 hours, the pipe work and system must be disinfected as per the instructions, and a full risk assessment must be undertaken to ensure safe operation.



WARNING!

Do not use oil, grease, glue, Teflon, silicone, O-ring lubrication, etc. when assembling pipe or hose connections. All of these products can lead to the growth of bacteria and thus pose health risks.

Only approved lubricant is: **Dishwashing liquid.**

When fitting water filters, hoses and other components in direct contact with water, wash your hands and wear sterile disposable gloves or touch only the packing foil to keep the filter and reverse osmosis membranes bacteria-free.

Do not remove dust protection caps on pipe and hose ends until just before assembly.



DANGER!
Handling carbon dioxide!

In the event of a fault in the hydraulic carbon dioxide-carrying connections, the breathing air in the room can be displaced by escaping carbon dioxide (CO₂). There is a risk of suffocation!

Prevention: Before replacing the CO₂ compressed gas bottle, close the bottle valve. Ensure that the room is adequately ventilated while replacing the CO₂ compressed gas bottle. After replacing the CO₂ compressed gas bottle, ensure that there are no leaks. If any are found, repair them immediately. The safety regulations for handling compressed gas containers, especially gas containers filled with carbon dioxide (CO₂), must be observed and adhered to.

For safety reasons, we strongly recommend installing a CO₂ sensor in the room, which will trigger an alarm in the event of a CO₂ leak.

Correct lifting and handling

Lifting or handling of components always carries an element of risk, and therefore must only be carried out by trained and qualified personnel. Ensure that any lifting operations have been fully planned and risk assessed. All equipment should be checked by a skilled and competent health & safety representative.

It is the customer's responsibility to ensure that operators are trained in handling heavy goods and to enforce the relevant lifting regulations.

Preventing unsafe operation

All persons working with the Condair Vita Power are obliged to report any alterations to the system and the associated installations that may affect safety to the owner without delay and to **secure the Condair Vita Power against accidental power-up**.



CAUTION!

In order that the Condair Vita Power does not remain in the error status unnoticed for a longer period of time in the event of a malfunction, errors must be signaled via a remote error indication (e.g. via the error relay of the optional remote operating and fault indication board or via the network via BACnet or Modbus).

Prohibited modifications to the unit

No modifications must be undertaken on the Condair Vita Power without the express written consent of the manufacturer. If necessary, contact your Condair representative.

For the replacement of defective components use exclusively **original accessories and spare parts** available from your Condair representative.

3 Product overview

3.1 Model overview

The Condair Vita Power is available in different models for different purposes and three different capacities 100 l/hr, 300 l/hr, 500 l/hr. The Condair Vita Power water treatment systems is delivered ready for connection.

Model	Water treatment units				
	RO Reverse osmosis	DI Deionization	CO CO ₂ enrichment	UV UV reactor	HP High Pressure
Condair Vita Power RO-DI-CO-UV-HP	X	X	X	X	X
Condair Vita Power RO-UV-HP	X			X	X
Condair Vita Power UV-HP				X	X
Condair Vita Power RO	X				

Depending on the model and the supply water quality the Condair Vita Power must be supplemented by additional upstream components (water softener, dechlorination, etc.).

3.2 System overview Condair Vita Power RO-DI-CO-UV-HP

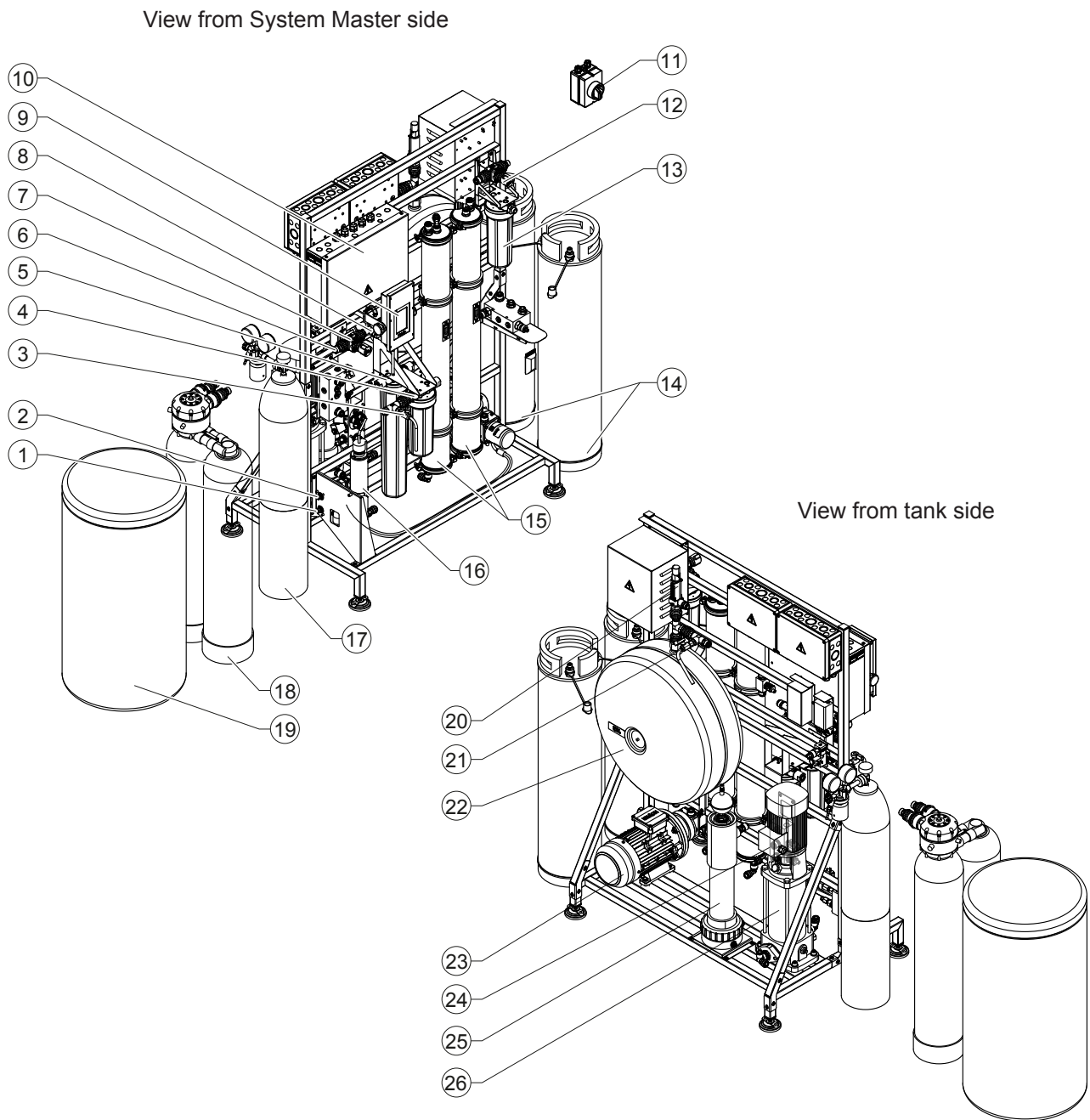

Fig. 1: System overview Condair Vita Power RO-DI-CO-UV-HP (image shows 500 l/hr version)

- | | | | |
|----|---|----|--|
| 1 | Outlet connector high pressure | 14 | Deionizing cartridges |
| 2 | Return connector high pressure | 15 | Reverse osmosis membranes |
| 3 | Sampling tap before high pressure pump (optional, sanitizable by flame) | 16 | UV reactor |
| 4 | Micro particle filter 5 µm before high pressure pump | 17 | CO ₂ pressure bottle with pressure reducing valve |
| 5 | Micro particle filter 5 µm (pre-filter) | 18 | Water softener (optional, recommended) |
| 6 | Water supply connection G 3/4" | 19 | Salt container water softener |
| 7 | Manual shut-off valve water inlet | 20 | Safety valve pressure tank |
| 8 | Sampling tap supply water inlet (sanitizable by flame) | 21 | Sampling tap supply after pressure tank (optional, sanitizable by flame) |
| 9 | External control unit | 22 | Pressure tank |
| 10 | System Master | 23 | High pressure pump |
| 11 | Electrical isolator (by client) | 24 | Water drain connection |
| 12 | Manual shut-off valve before deionizing cartridges | 25 | CO ₂ -mixing unit |
| 13 | Micro particle filter 5 µm after deionizing cartridges | 26 | Reverse osmosis pump |

3.3 System overview Condair Vita Power RO-UV-HP

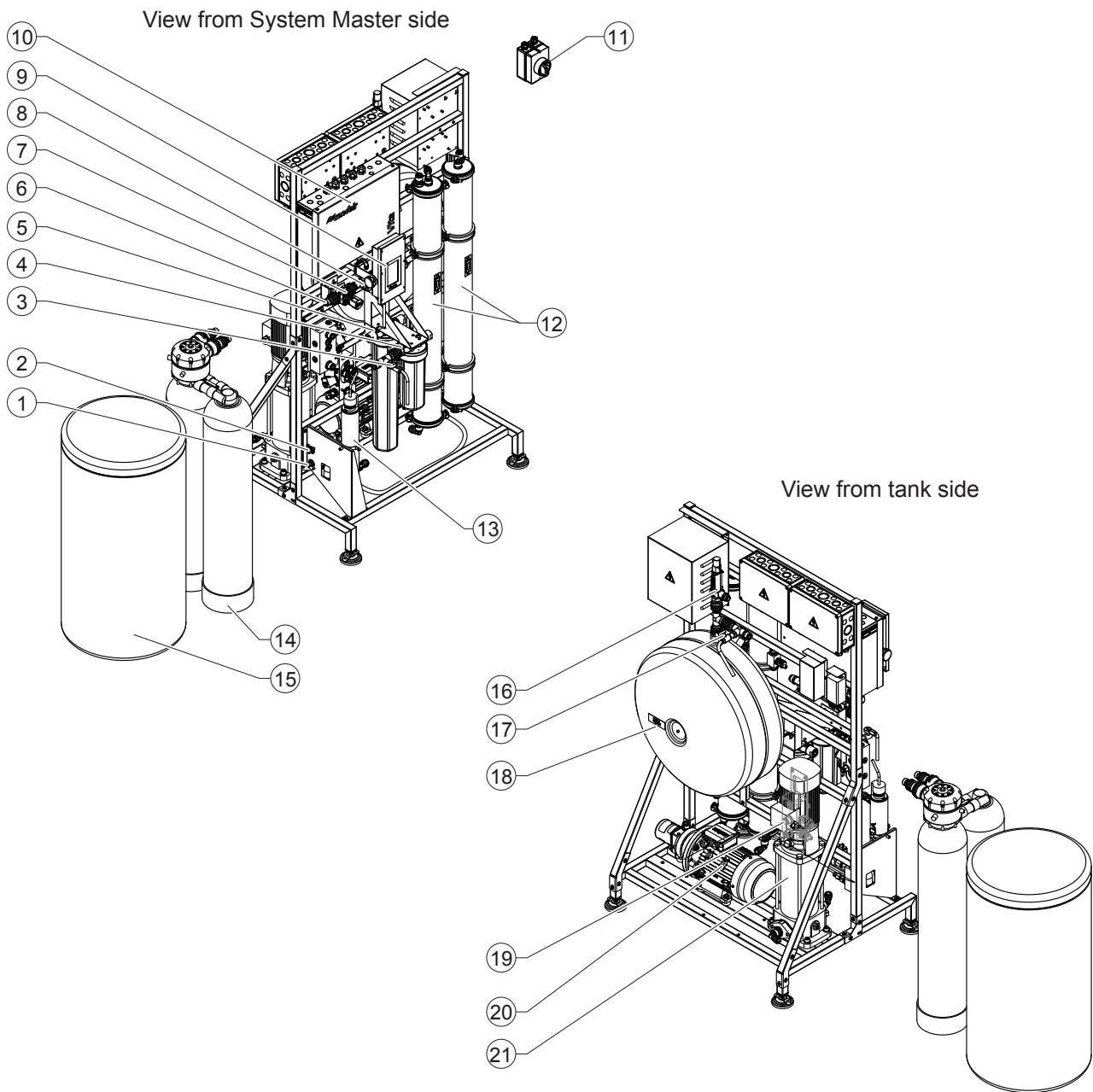

Fig. 2: System overview Condair Vita Power RO-UV-HP (image shows 500 l/hr version)

- | | | | |
|----|---|----|--|
| 1 | Outlet connector high pressure | 12 | Reverse osmosis membranes |
| 2 | Return connector high pressure | 13 | UV reactor |
| 3 | Sampling tap before high pressure pump (optional, sanitizable by flame) | 14 | Water softener (optional, recommended) |
| 4 | Micro particle filter 5 µm before high pressure pump | 15 | Salt container water softener |
| 5 | Micro particle filter 5 µm (pre-filter) | 16 | Safety valve pressure tank |
| 6 | Water supply connection G 3/4" | 17 | Sampling tap supply after pressure tank (optional, sanitizable by flame) |
| 7 | Manual shut-off valve water inlet | 18 | Pressure tank |
| 8 | Sampling tap supply water inlet (sanitizable by flame) | 19 | Water drain connection |
| 9 | External control unit | 20 | High pressure pump |
| 10 | System Master | 21 | Reverse osmosis pump |
| 11 | Electrical isolator (by client) | | |

3.4 System overview Condair Vita Power UV-HP

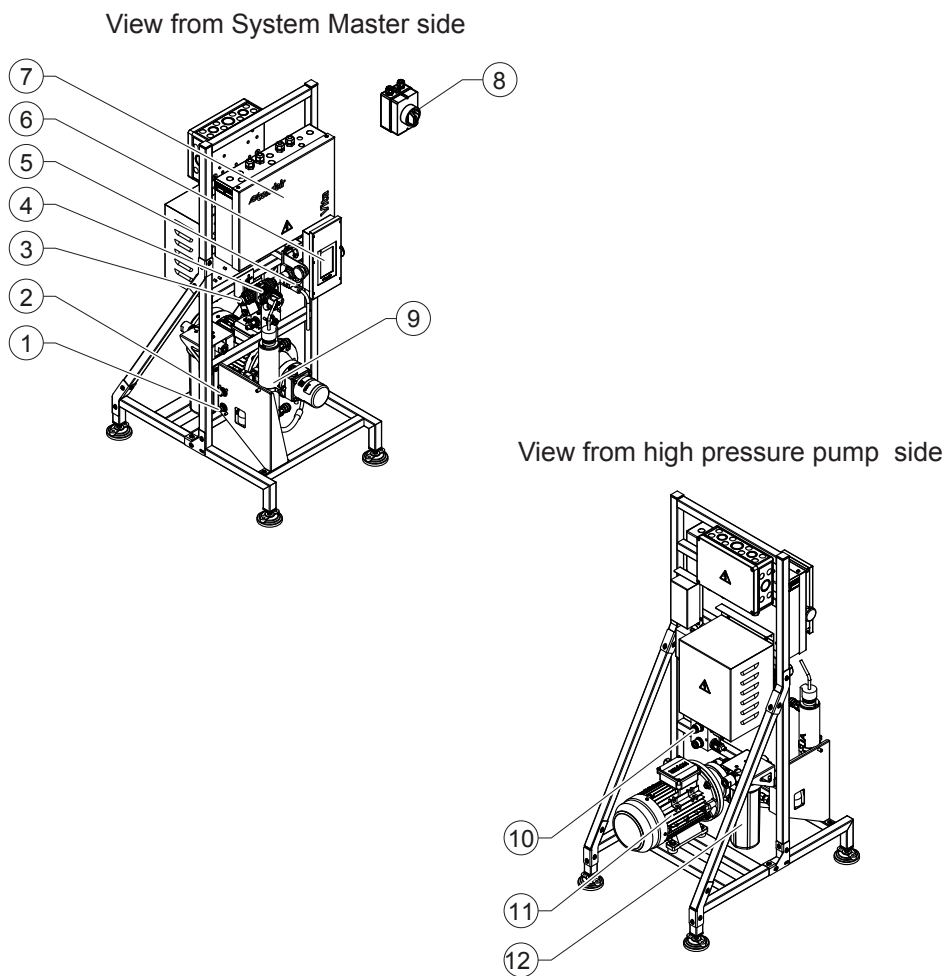

Fig. 3: System overview Condair Vita Power UV-HP (image shows 500 l/hr version)

- | | | | |
|---|---|----|--|
| 1 | Outlet connector high pressure | 7 | System Master |
| 2 | Return connector high pressure | 8 | Electrical isolator (by client) |
| 3 | Water supply connection G 3/4" | 9 | UV reactor |
| 4 | Manual shut-off valve water inlet | 10 | Water drain connection |
| 5 | Sampling tap water inlet (sanitizable by flame) | 11 | High pressure pump |
| 6 | External control unit | 12 | Micro particle filter 5 µm before high pressure pump |

3.5 System overview Condair Vita Power RO

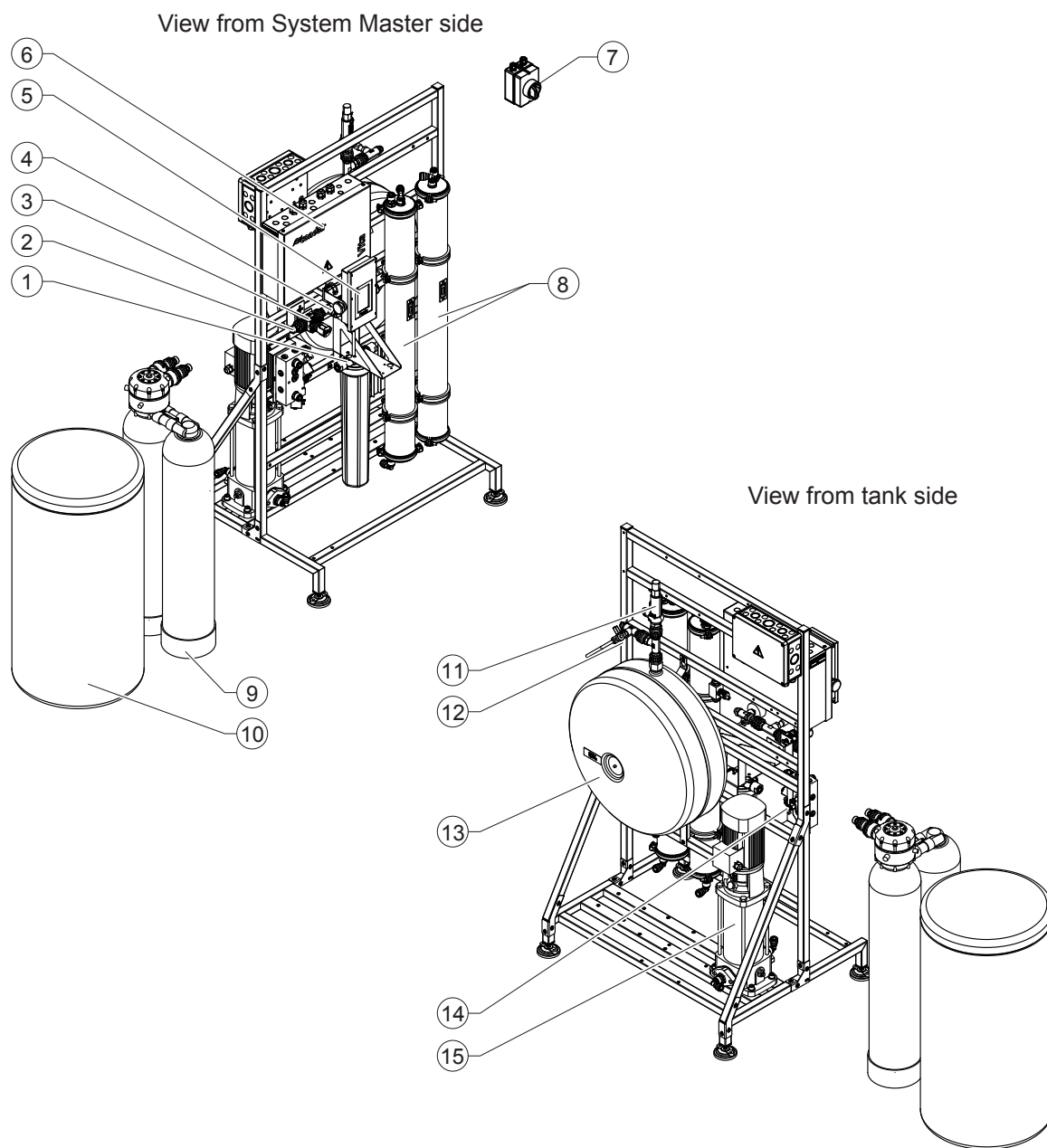

Fig. 4: System overview Condair Vita Power RO (image shows 500 l/hr version)

- | | | | |
|---|---|----|--|
| 1 | Micro particle filter 5 µm | 9 | Water softener (optional, recommended) |
| 2 | Water supply connection G 3/4" | 10 | Salt container water softener |
| 3 | Manual shut-off valve water inlet | 11 | Safety valve pressure tank |
| 4 | Sampling tap water inlet (sanitizable by flame) | 12 | Sampling tap supply after pressure tank (optional, sanitizable by flame) |
| 5 | External control unit | 13 | Pressure tank |
| 6 | System Master | 14 | Water drain connection |
| 7 | Electrical isolator (by client) | 15 | Reverse osmosis pump |
| 8 | Reverse osmosis membranes | | |

Note: The Condair Vita Power RO does not have a high pressure stage.

4 Operation

The Condair Vita Power may be commissioned and operated only by persons familiar with the Condair Vita Power and adequately qualified. It is the owner's responsibility to verify proper qualification of the personnel.

4.1 First-time commissioning

The first-time commissioning must always be done by a service technician of your Condair representative or a well-trained and authorized person of the customer. Therefore, the current manual does not provide detailed information on this procedure.

The following steps are carried out upon first-time commissioning in the specified order:

- Inspecting the system components for correct installation.
- Inspecting the electrical installation
- Inspecting the water installation
- Flushing the water supply line and testing the water quality.
- Configuring the control unit or the Condair Vita Power water treatment system, respectively.
- Commissioning the system.
- Fill in the commissioning protocol.

4.2 Display and operating elements

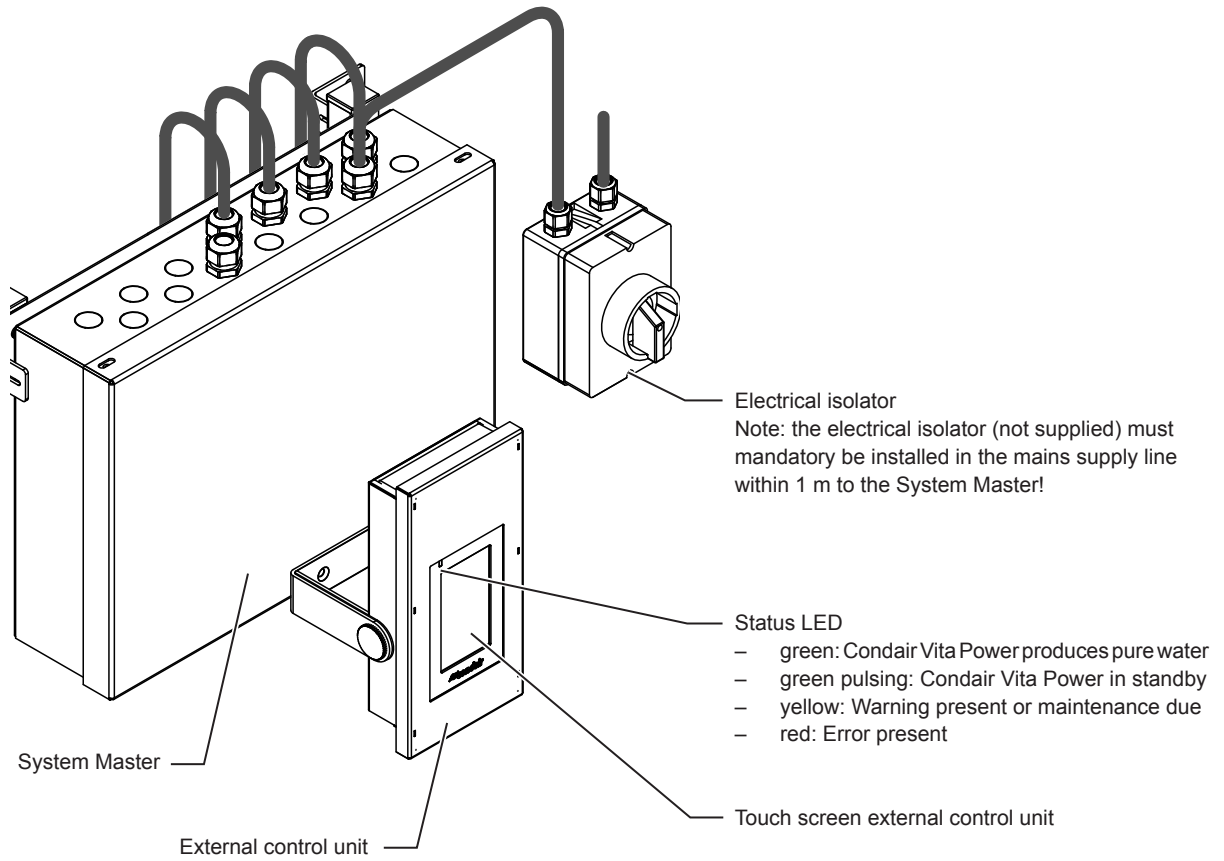

Fig. 5: Display and operating elements

4.3 Recommissioning after interruption of operation

The following description outlines the recommissioning procedure after an interruption of the operation (e.g., after servicing the system). It is assumed that first-time commissioning has been carried out properly by the service technician of your Condair representative. Proceed as follows to prepare the Condair Vita Power for operation:

1. Examine the system components and installations for possible damage.



DANGER!

Damaged systems or systems with damaged components or installations may present danger to human life or cause severe damage to material assets.

Damaged systems and/or systems with damaged or faulty installations must not be operated.

2. Make sure all covers of the system components are correctly installed and secured.
3. **Switch on the electrical isolator in the mains supply line** (mains supply to System Master).
4. If closed, open shut-off valve in the water supply line.
5. If filters has been replaced, deaerate the filters.

The Condair Vita Power is now in **normal operating mode** and the **home screen** is shown in the display.

Note: Further information on the operation of the Condair Vita Power control software can be found in [Section 5](#).

4.4 Notes on operation

4.4.1 Important notes on operation

- For hygiene reasons, the Condair Vita Power is flushed **every 4 hours as standard**.
Note: Depending on the certification standard of your Condair Vita Power (e.g. ISO 22000), different purge times may be set for standby mode.
- In Condair Vita Power models RO-DI-CO-UV-HP, RO-UV-HP and UV-HP, the water temperature before the high-pressure pump is monitored during operation. If the water temperature rises above 25°C, an warning is triggered. If the water temperature rises to 35°C (VDI certified system: 30°C), a flushing cycle is automatically performed to ensure hygienically reliable operation.

4.4.2 Remote operating and fault indication

Via the relays on the optional operating and fault indication board the following error and device status are indicated:

Activated remote indication relay	When?
"Error"	An error is present, operation is stopped, or further operation is possible for a limited period of time only.
"Service"	One of the maintenance counters has elapsed or a warning has been triggered. The corresponding maintenance must be performed.
"Running"	Demand present Condair Vita Power is operating.
"Unit on"	The Condair Vita Power system is switched on and under voltage.

Important: It must be ensured that an upcoming error or maintenance alert is forwarded and responded to within 8 hours. The Condair Vita Power offers the following options for this:

- Signaling via the IoT interface.
- Signaling via the BACnet or Modbus interface to the building management system.
- Signaling via the corresponding relays of the remote operating and fault indication board to a signal lamp, siren, etc. (customer responsibility).

4.4.3 Regular checks during operation

During operation, carry out the following regular checks:

Inspection work to be carried out	see	Interval
Check the Condair Vita Power water treatment system	Section 4.4.3.1	Every four weeks
Check the salt level of the optional water softener if the salt level is not monitored electronically.	Section 4.4.3.2	Every two days

4.4.3.1 Check the Condair Vita Power water treatment system

During operation, the Condair Vita Power must be checked regularly. On this occasion check the following:

- the hydraulic system for any leak.
- the components of the for correct installation and any damage.
- the electric installation for any damage.
- the display for whether a warning or error message is present.

If the inspection reveals any irregularities (e.g., leak, error indication) or any damaged components take the Condair Vita Power out of operation as described in [Section 4.6](#). Then, have the malfunction be corrected or the damaged component be replaced by a well-trained specialist or a service technician from your Condair representative.

4.4.3.2 Check the salt level of the optional water softener

See separate instructions for the corresponding water softener.

4.5 Manual functions

4.5.1 Refreshing the reverse osmosis

Note: if an error message is active the reverse osmosis refreshment is not possible.

To perform a refreshment of the reverse osmosis, proceed as follows:

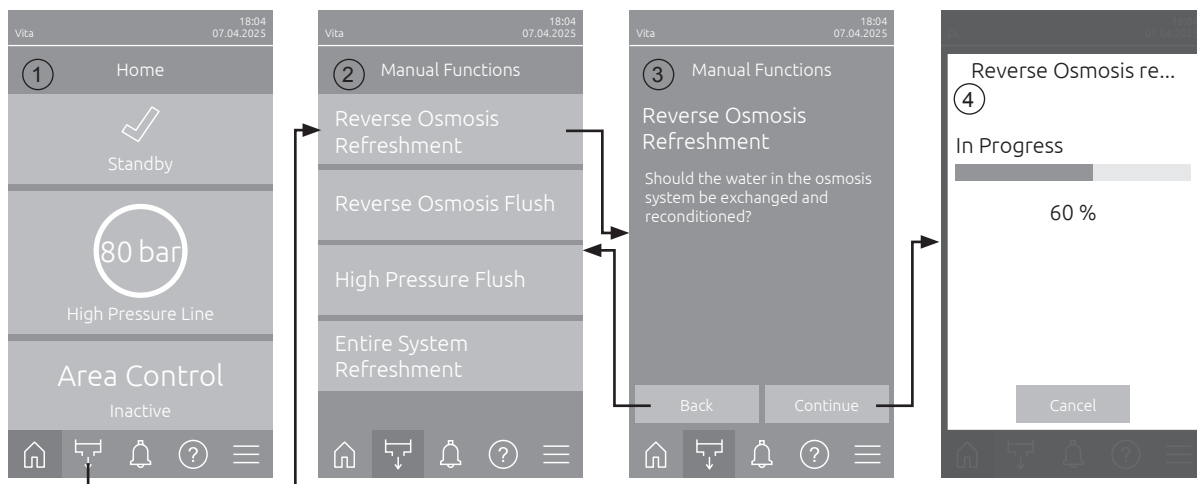

1. Press on the **<Manual Functions>** button in the home screen (1).
2. The "Manual Functions" submenu (2) appears. Here, press on the **<Reverse Osmosis Refreshment>** button.
3. The reverse osmosis refreshment confirmation display appears. Here, press on the **<Continue>** button to start the reverse osmosis refreshment.

Note: The refresh cycle of the reverse osmosis will only start if the system has been in standby mode for an extended period. Otherwise, the refresh cycle does **not** start, and the display returns to the home screen.

4. The refreshment progress display appears (4) and shows the current status of the reverse osmosis refreshment cycle. After the refreshment cycle has finished the home screen is shown again.

In order to stop the reverse osmosis refreshment cycle, press the **<Cancel>** button in the progress window. The refreshment cycle is stopped, and the home screen is shown again.

4.5.2 Flushing the reverse osmosis

Note: if an error message is active flushing of the reverse osmosis is not possible.

To perform a flushing of the reverse osmosis, proceed as follows:

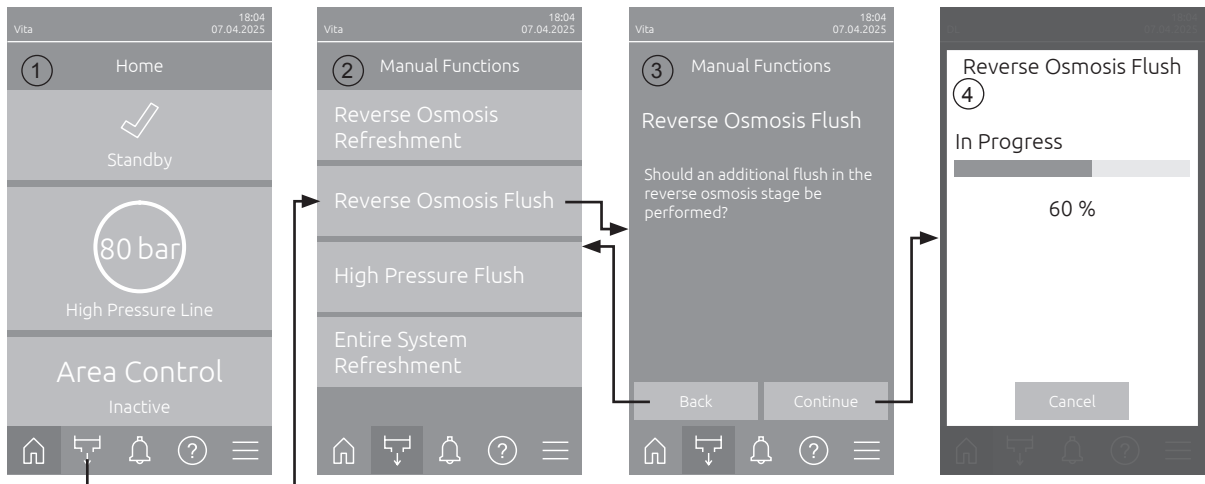

1. Press on the **<Manual Functions>** button in the home screen (1).
2. The "Manual Functions" submenu (2) appears. Here, press on the **<Reverse Osmosis Flush>** button.
3. The reverse osmosis flushing confirmation display appears. Here, press on the **<Continue>** button to start the flushing of the reverse osmosis.

Note: The flushing cycle of the reverse osmosis will only start if the system has been in standby mode for an extended period. Otherwise, the flushing cycle does **not** start, and the display returns to the home screen.

4. The flushing progress display appears (4) and shows the current status of the reverse osmosis flushing cycle. After flushing cycle has finished the home screen is shown again.

In order to stop the reverse osmosis flushing cycle, press the **<Cancel>** button in the flushing progress window. The flushing cycle is stopped, and the home screen is shown again.

4.5.3 Flushing the high pressure system

Note: if an error message is active flushing of the osmosis system is not possible.

To perform a flushing of the osmosis system, proceed as follows:

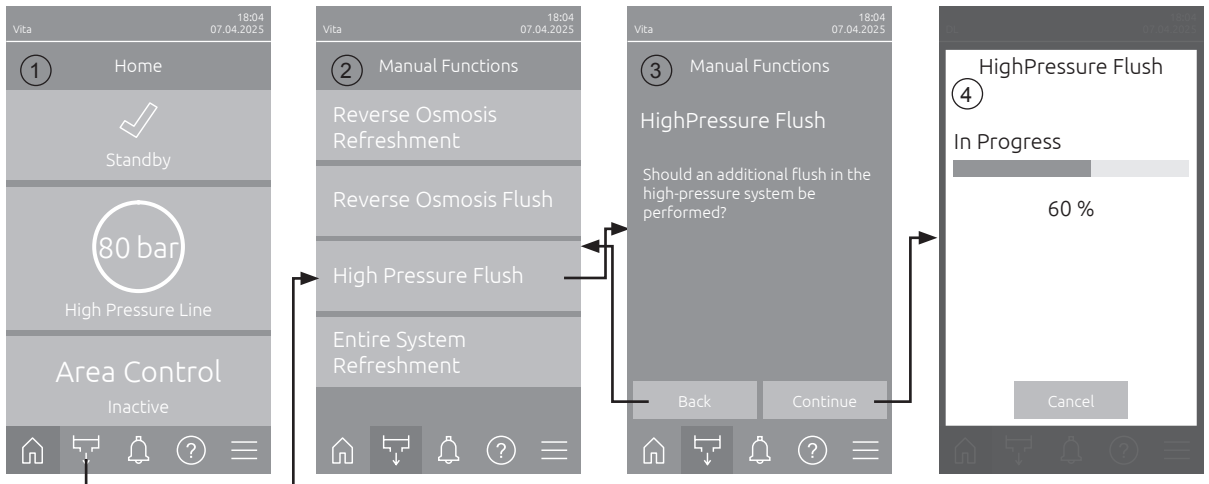

1. Press on the **<Manual Functions>** button in the home screen (1).
2. The "Manual Functions" submenu (2) appears. Here, press on the **<High Pressure Flush>** button.
3. The high pressure system flushing confirmation display appears. Here, press on the **<Continue>** button to start the flushing of the high pressure system.
Note: The flushing cycle of the high pressure system will only start if the system has been in standby mode for an extended period. Otherwise, the flushing cycle does **not** start, and the display returns to the home screen.
4. The flushing progress display appears (4) and shows the current status of the high pressure system flushing cycle. After flushing cycle has finished the home screen is shown again.
In order to stop the high pressure system flushing cycle, press the **<Cancel>** button in the flushing progress window. The flushing cycle is stopped, and the home screen is shown again.

4.5.4 Refreshing the entire system

Note: if an error message is active the refreshment of the entire system is not possible.

To perform a refreshment of the entire system, proceed as follows:

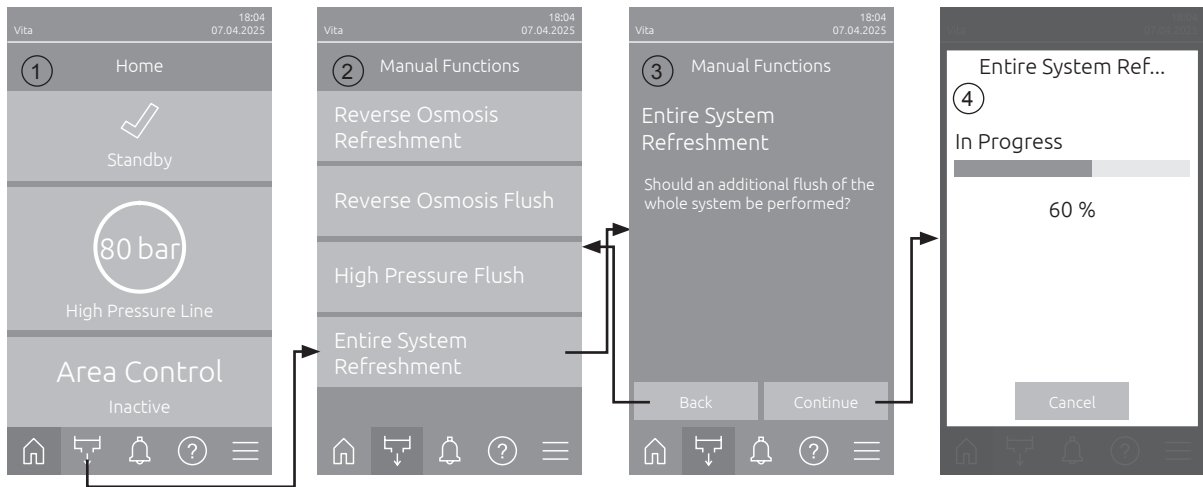

1. Press on the **<Manual Functions>** button in the home screen (1).
2. The "Manual Functions" submenu (2) appears. Here, press on the **<Entire System Refreshment>** button.
3. The confirmation display for the refreshment of the entire system appears. Here, press on the **<Continue>** button to start the osmosis refreshment of the entire system.
Note: The refresh cycle of the entire system will only start if the system has been in standby mode for an extended period. Otherwise, the refresh cycle does **not** start, and the display returns to the home screen.
4. The refreshment progress display appears (4) and shows the current status of the refreshment cycle. After refreshment cycle has finished the home screen is shown again.

In order to stop the refreshment cycle of the entire system, press the **<Cancel>** button in the refreshment progress window. The refreshment cycle of the entire system is stopped, and the home screen is shown again.

4.6 Temporary decommissioning

Important! Basically, the Condair Vita Power should not be switched off by the customer, as this is the only way to ensure that the system is flushed at regular intervals and that the hygiene of the system is guaranteed.

If the Condair Vita Power needs to be temporarily shut down for any reason, proceed as follows:

1. Close the shut-off valve in the water supply line.
2. **Switch off electrical isolator in the mains supply line to the System Master** and secure electrical isolator in the "Off" position against accidentally switching on.

Important information on extended periods of non-use

If the Condair Vita Power has been out of service for more than 72 hours, it will no longer be operational. In this case, contact your Condair representative.

5 Operating the Condair Vita Power control software

5.1 Home screen

After switching on the control unit and the automatic system test the control unit is in **normal operating** mode and the **home screen** is shown.

Note: The appearance of the home screen depends on the current device and error status and the configuration of the system. It can deviate from the display shown below.

The home screen is structured as follows:

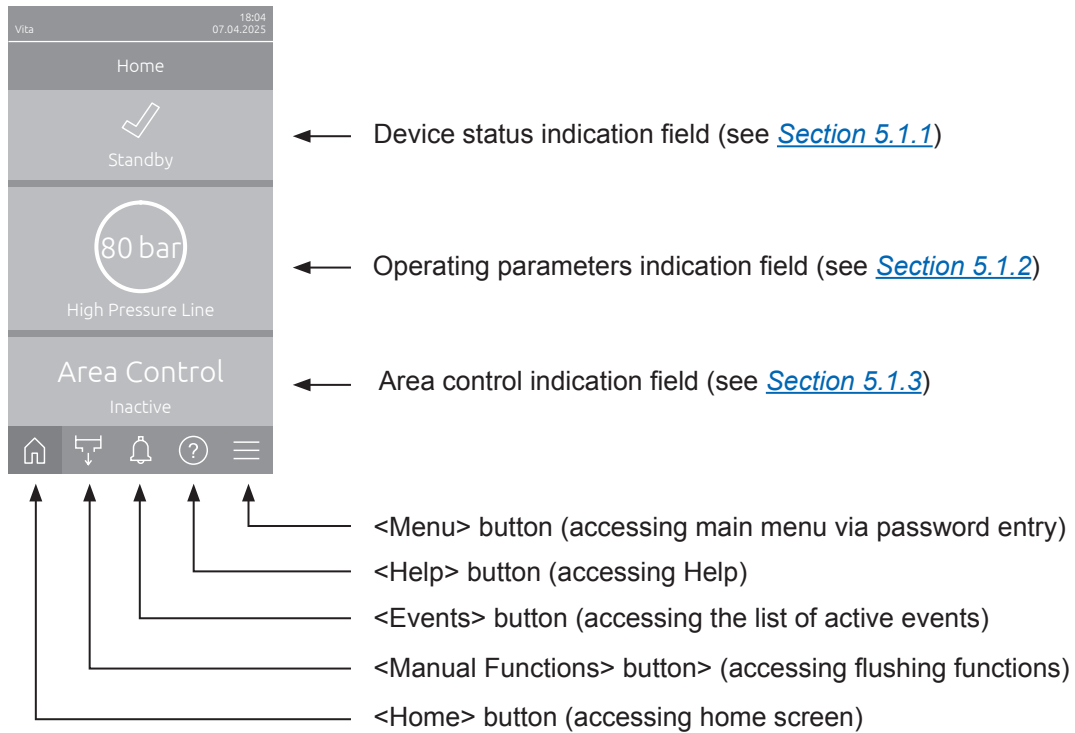
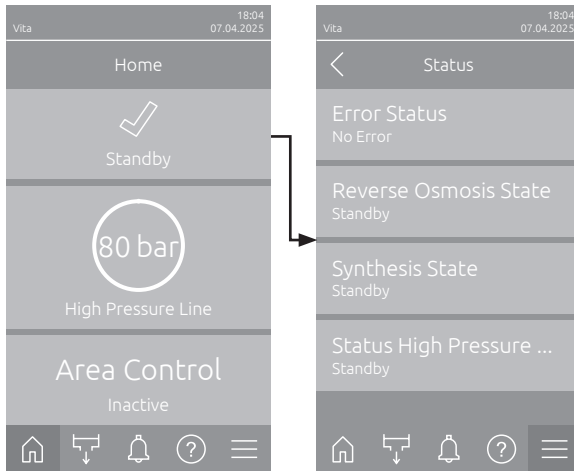

Fig. 6: Home screen

5.1.1 Device status indication field

If you press the **<Device Status>** indication field in the home screen, a window appears with further information on the device and error status.



- **Error Status:** Shows the current error status ("No Error", "Warning" or "Error").
- **Reverse Osmosis State:** Shows the current status of the reverse osmosis stage.
Note: This parameter only appears on the Condair Vita Power models RO-DI-CO-UV-HP, RO-UV-HP and RO.
- **Synthesis State:** Shows the current status of the synthesis stage.
Note: This parameter only appears on the Condair Vita Power model RO-DI-CO-UV-HP.
- **Status High Pressure Line:** Shows the current status of the high pressure line.
Note: This parameter only appears on the Condair Vita Power models RO-DI-CO-UV-HP, RO-UV-HP and UV-HP.

The following error status symbols may be shown:

Error status symbol	Description
✓	The Condair Vita Power works perfectly.
!	An event with the status "Warning" has occurred.
✗	An event with the status "Error" has occurred. Depending on the fault, the operation of the Condair Vita Power is stopped, or it continues to work to a limited extent.

The following device status indications may appear:

Device status	Description
Standby	The osmosis stage, high pressure stage and, if applicable, the synthesis stage are in standby mode.
Producing	The high pressure stage provides water for the high pressure line.
Producing but no water	Production demand exists, but the inlet pressure is too low for production.
Holding	The high pressure line is filled with water and waits for a demand from the zones.
Flushing	The high pressure stage is flushed.
Flushing no water	Pressure to flush the high pressure stage is too low.
Water Softener Regenerating	The water softener is being regenerated.
Stopped	The system was stopped due to an error or another reason that made further operation impossible.

5.1.2 Operating parameter field

If you press the **<Operating parameter>** indication field in the home screen, a window appears with the most important current operating parameters.

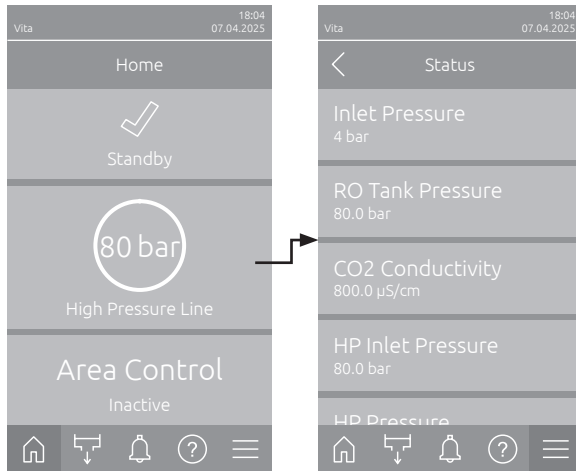

- **Inlet Pressure:** Shows the current inlet water pressure in bar.
Note: When the inlet valve is closed, the value "0" is displayed.
- **RO Tank Pressure:** Shows the current reverse osmosis tank pressure in bar.
Note: This parameter only appears on the Condair Vita Power model RO-DI-CO-UV-HP, RO-UV-HP and RO.
- **CO2 Conductivity:** Shows the current conductivity of the water to be nebulized in µS/cm an.
Note: This parameter only appears on the Condair Vita Power models RO-DI-CO-UV-HP, RO-UV-HP and RO.
- **HP Inlet Pressure:** Shows the current pressure before the high pressure pump in bar.
Note: This parameter only appears on the Condair Vita Power models RO-DI-CO-UV-HP, RO-UV-HP and UV-HP.
- **HP Pressure:** Shows the current pressure after the high pressure pump in bar.
Note: This parameter only appears on the Condair Vita Power models RO-DI-CO-UV-HP, RO-UV-HP and UV-HP.

5.1.3 Area control field

If you press the **<Area Control>** indication field in the home screen, a window appears with the current humidity in %rh, the current temperature in °C and the status of the individual humidification areas. Further more you can set the humidity setpoint for all areas or individually for each humidification area.

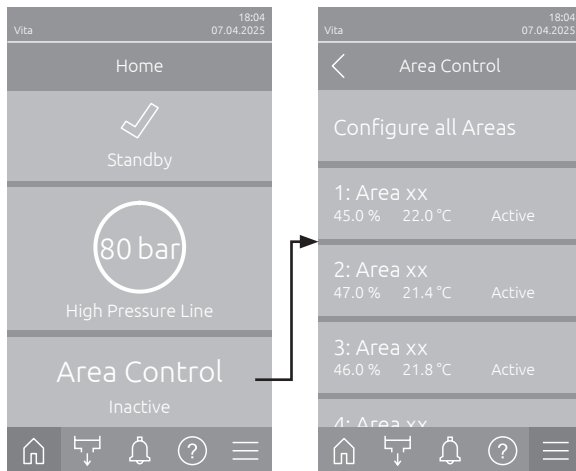

- **Configure all Areas:** With this function you can set a common humidity setpoint in %rh which is valid for all areas.
- **1: Area xx ... 10: Area xx:** Shows the current humidity in %rh, the current temperature and the status of the individual humidification areas. By pressing an areas button you can set an individual humidity setpoint in %rh for the selected area.
Note: If names have been assigned to the zones, the corresponding names are displayed instead of the designations Area01 ... Areaxx.

5.2 Information functions in the "Help" Menu

5.2.1 Assessing the "Help" menu

Press the <Help> button in the home screen. The help menu with the contact details appears.

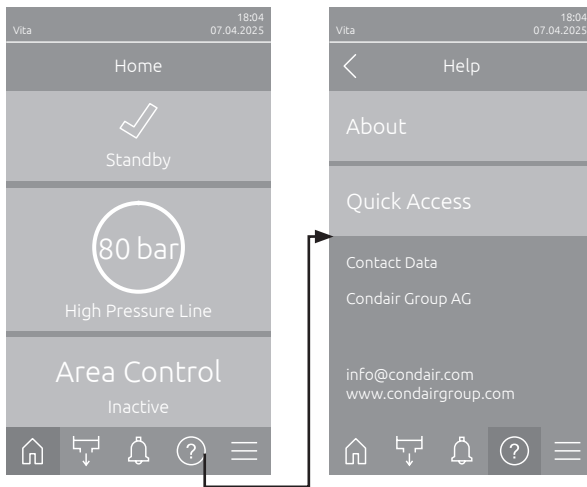

5.2.2 Query operating states in the "About" submenu

Press the <About> button in the "Help" menu. The "About" menu appears.

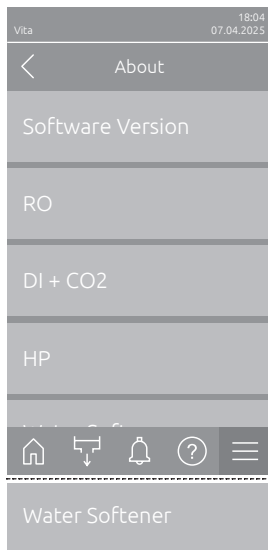

- **Software Version:** Access to software versions.
- **RO:** Access to information about the reverse osmosis module.
Note: This parameter only appears on the Condair Vita Power models RO-DI-CO-UV-HP, RO-UV-HP and RO.
- **DI + CO₂:** Access to information about the deionization and CO₂ module.
Note: This parameter only appears on the Condair Vita Power model RO-DI-CO-UV-HP.
- **HP:** Access to information about the UV and high-pressure module.
Note: This parameter only appears on the Condair Vita Power models RO-DI-CO-UV-HP, RO-UV-HP and UV-HP.
- **Water Softener:** Access to information about the water softener.
Note: This parameter only appears, if a water softener is connected to the Condair Vita Power.

5.2.2.1 Query software versions in the "About > Software Version" submenu

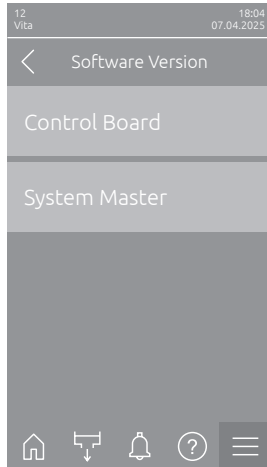

- **Control Board:** Actual software versions of the control board of the external control unit ("Device FW Version" and "Bootloader FW Version").
- **System Master:** Actual software version of the System Master control board ("Device FW Version")

5.2.2.2 Query reverse osmosis unit information in the "About > RO" submenu

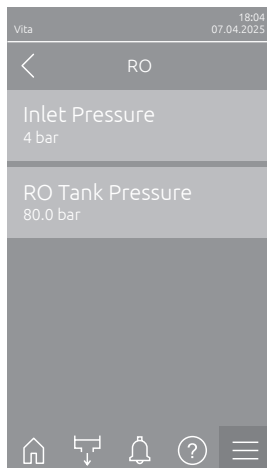

- **Inlet Pressure:** Shows the actual inlet pressure of the osmosis stage in bar.
- **RO Tank Pressure:** Shows the actual pressure of the osmosis water tank in bar.

5.2.2.3 Query Deionizing and CO₂ unit information in the "About > DI + CO₂" submenu

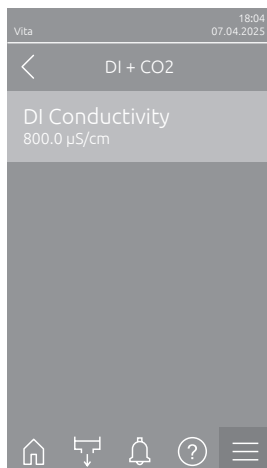

- **DI Conductivity:** Shows the actual conductivity of the water to be nebulized in µS/cm.

5.2.2.4 Query high pressure unit information in the "About > HP" submenu



- **HP Inlet Pressure:** Shows the actual inlet pressure of the high pressure pump in bar.
- **HP Pump Temperature:** Shows the actual temperature of the high pressure pump in °C.
- **HP Pressure:** Shows the actual pressure of the high pressure line in bar.
- **Start Valves with Delay:** Shows whether the valves are started with delay ("Yes") or not ("No").

5.2.2.5 Query water softener information in the "About > Water softener" submenu

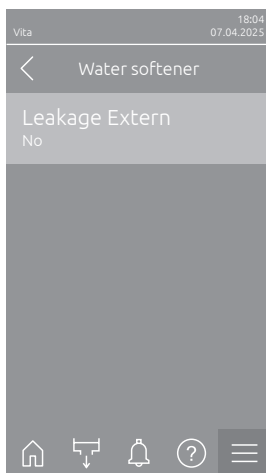

- **Leakage Extern:** Shows whether the optional external leak sensor has detected a leak ("Yes") or not ("No").

5.2.3 Quick access to setting parameters in the "Quick Access" submenu

Press the <Quick Access> button in the "Help" menu. Then enter the quick access number of the desired setting parameter. You will find this number in the top left corner in the setting window of the corresponding parameter. Confirm the entry and the setting dialog for the corresponding parameter appears.

Note: If the parameter is password protected, after entering the quick access number, the password "8808" must first be entered before the setting dialog for the parameter appears.

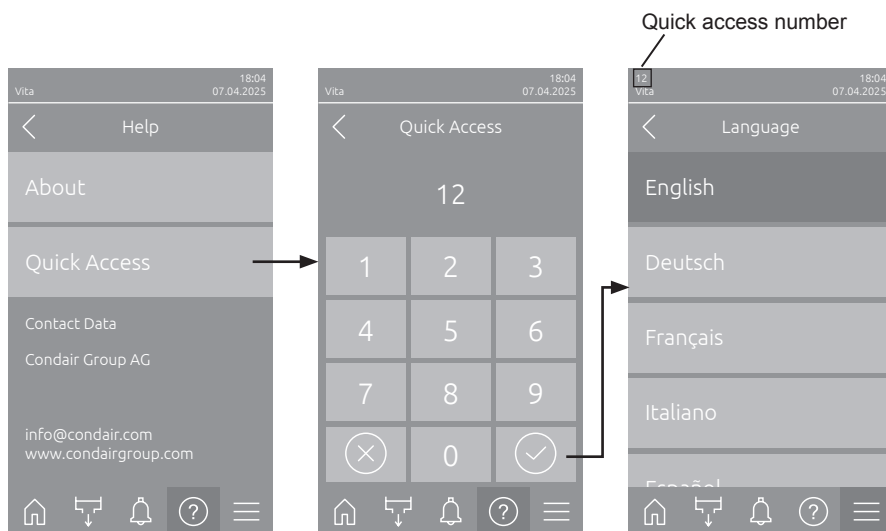

5.3 Configuration

5.3.1 Settings and features in the "General" submenu

5.3.1.1 Accessing the "General" submenu

Access the "General" submenu as shown below.

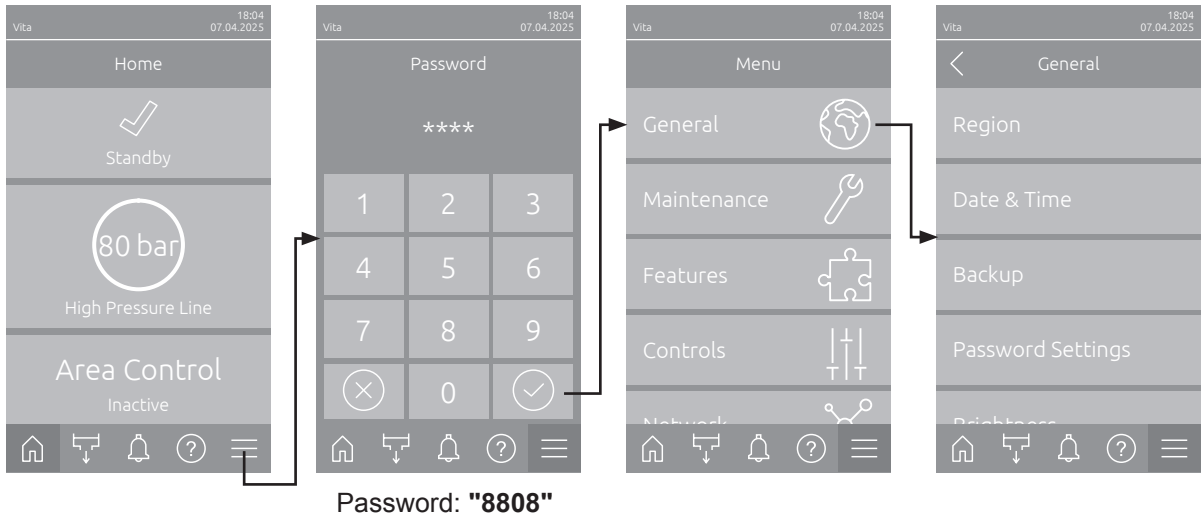

5.3.1.2 Determine language and system of units in the "Region" submenu



- **Language:** With this setting you determine the language.
Factory setting: **depending on the country**
Options: **different languages**
- **Units:** With this setting you determine the desired unit system.
Factory setting: **depending on the country**
Options: **Metric or Imperial**

5.3.1.3 Date and time settings in the "Date & Time" submenu

Note: The date and time must be entered correctly, as these are used for the entries in the malfunctions and maintenance history list.

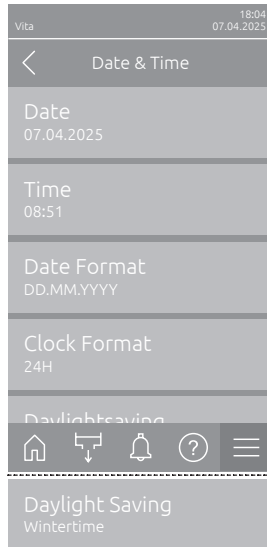

- **Date:** With this setting you determine the current date in the set format ("MM/DD/YYYY" or "DD.MM.YYYY").
Factory setting: **01/01/2020**
- **Time:** With this setting you set the current hour of the day in the set time format ("12H" or "24H").
Factory setting: **12:00**
- **Date Format:** With this setting you determine the desired date format.
Factory setting: **DD.MM.YYYY**
Options: **DD.MM.YYYY** or **MM/DD/YYYY**
- **Clock Format:** With this setting you determine the desired time format.
Factory setting: **24H**
Options: **24H** (24 hours, display 13:35) or **12H** (12 hours, display: 01:35 PM)
- **Daylight Saving:** With this setting you determine the daylight saving time summer time / winter time).
Factory setting: **Wintertime**
Options: **Summertime** or **Wintertime**

5.3.1.4 Read in parameter settings in the "Backup" submenu

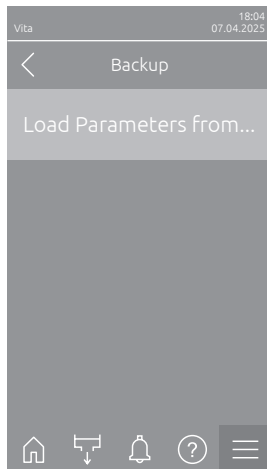

- **Load Parameters from USB:** With this function you can read in parameter settings that were previously saved on a FAT32 formatted USB stick. To do this, the USB stick with the parameter settings must be inserted into the USB interface on the control board. After pressing the selection field, a confirmation dialog appears in which you have to confirm the loading of the parameter settings again.

5.3.1.5 Activate/Deactivate password protection in the "Password Settings" submenu

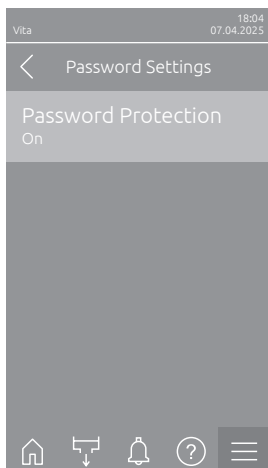

- **Password Protection:** With this function you can protect the access to the main menu with the user password "8808" against unauthorized access ("On") or not ("Off").
Factory setting: **On**
Options: **Off or On**

5.3.1.6 Set the brightness of the touchscreen and the LED in the "Brightness" submenu

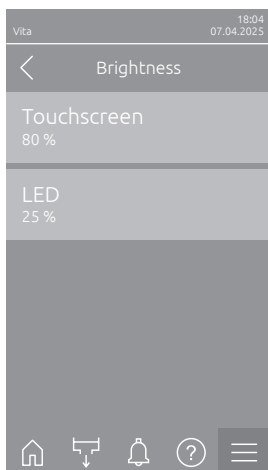

- **Touchscreen:** With this setting you determine the desired value for the display brightness.
Factory setting: **80 %**
Settings range: **15 ... 100 %**
- **LED:** With this setting you determine the desired value for the brightness of the status LED.
Factory setting: **25 %**
Settings range: **25 ... 100 %**

5.3.2 Settings and features in the "Maintenance" submenu

5.3.2.1 Accessing the "Maintenance" submenu

Access the "Maintenance" submenu as shown below.

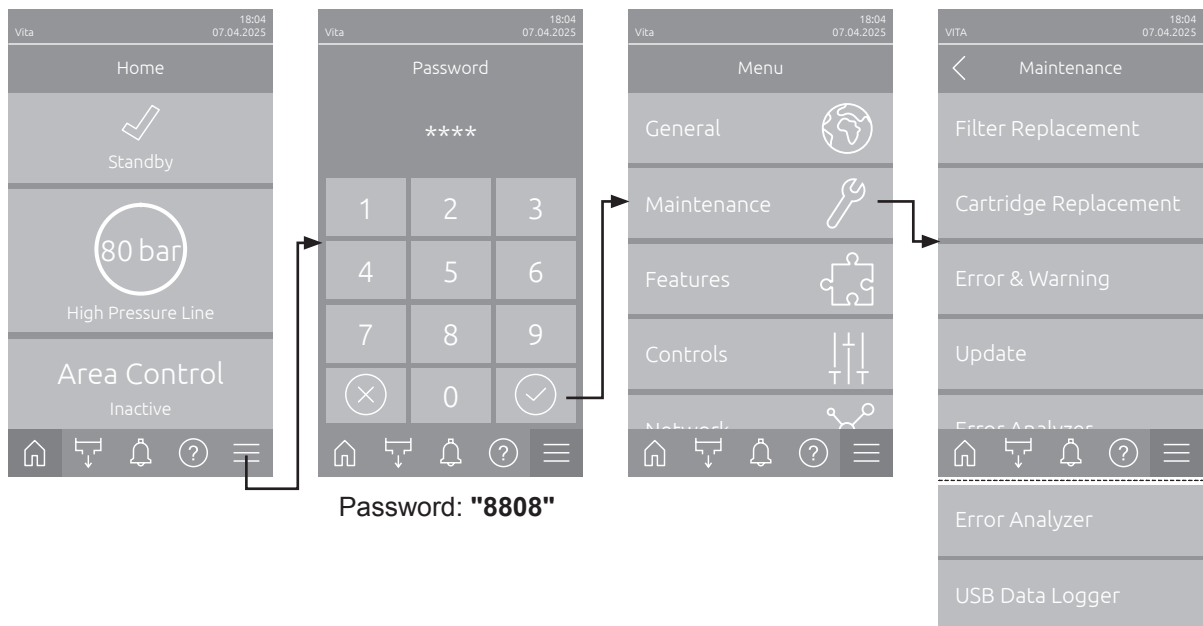

5.3.2.2 Start the wizard for replacing the micro particle filter(s)



Via the "Filter Replacement" function in the maintenance menu you can start the wizard for the software-supported replacement of the micro particle filter(s). Please refer to the information in [Section 6.4.1](#).

5.3.2.3 Start the wizard for replacing the deionizing cartridges



Via the "Cartridge Replacement" function in the maintenance menu you can start the wizard for the software-supported replacement of the deionizing cartridge. Please refer to the information in [Section 6.4.2](#).

5.3.2.4 Functions in the "Error & Warning" submenu

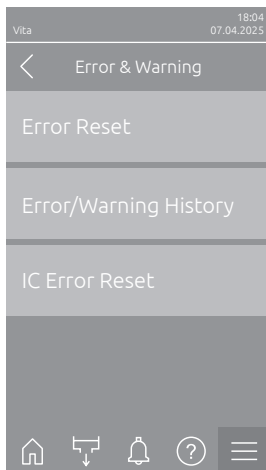

- **Error Reset:** With this function you can reset an active error of the System Master.
- **Error/Warning History:** With this function you can view the error and warning history list.
- **IC2 Error Reset:** With this function you can reset an active error of the IC2 control unit.

5.3.2.5 Software update in the "Update" submenu

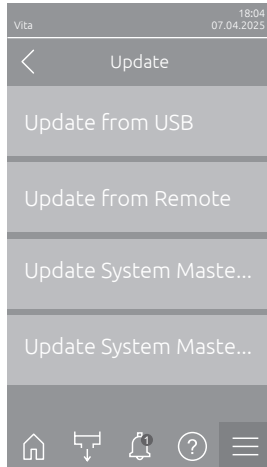

- **Update from USB:** With this function you can update the control software of the external control unit. The software update file is downloaded directly from the USB stick and then installed (see [Section 6.4.4](#)).
- **Update from Remote:** With this function you can update the control software of the external control unit. The software update file must first be transferred to the external control unit by Condair (see [Section 6.4.4](#)).
Note: This menu item only appears if the software update file is present on the external control unit. As soon as the software update file is present on the external control unit, a corresponding message is displayed in the event list (Accessing the event list see [Section 5.1](#)).
Important: If the external control unit is switched off and on again before the software update has been performed, the software update file will be deleted and must be transferred to the external control unit again by Condair.
- **Update System Master from USB:** With this function you can update the control software of the System Master. The software update file is downloaded directly from the USB stick and then installed (see [Section 6.4.4](#)).
- **Update System Master from Remote:** With this function you can update the control software of the System Master. The software update file must first be transferred to the external control unit by Condair (see [Section 6.4.4](#)).
Note: This menu item only appears if the software update file is present on the external control unit. As soon as the software update file is present on the external control unit, a corresponding message is displayed in the event list (Accessing the event list see [Section 5.1](#)).
Important: If the external control unit is switched off and on again before the software update has been performed, the software update file will be deleted and must be transferred to the external control unit again by Condair.

5.3.2.6 Load and export the error log file in the "Error Analyzer" submenu

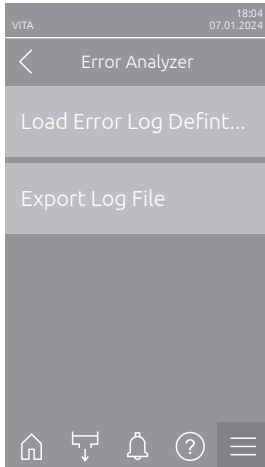

- **Load Error Log Definition** (carried out ex works): With this function you can load an "Error Log Definition file" available from Condair on a USB stick for recording malfunctions. Once the "Error Log Definition file" has been loaded, an error log file is created as soon as an error occurs during operation. This file can then be saved on a USB stick using the "Export Log File" function.
Note: Before you carry out this function, you must insert a USB stick with the "Error Log Definition" file into the USB interface on the control board.
- **Export Log File:** With this function you can save an error log file created by the control on a USB stick and send it to Condair for further analysis.
Note: Before you carry out this function, you must insert a FAT32 formatted USB stick into the USB interface on the control board.

5.3.2.7 Start operating data recording in the "USB Data Logger" submenu

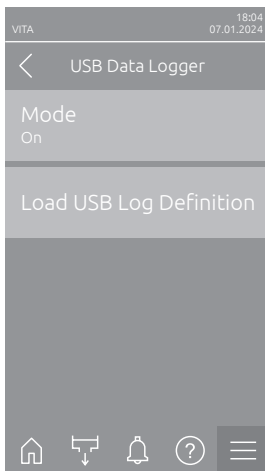

- **Mode:** With this function you can switch the operating data recording on a USB stick on or off. A new csv file is created for each day and stored on the USB stick.
Note: Before you carry out this function, you must insert a FAT32 formatted USB stick into the USB interface on the control board.
Factory setting: **Off**
Options: **Off or On**
- **Load USB Log Definition** (carried out ex works): With this function you can load a "USB log Definition file" available from Condair on a USB stick. This file determines which parameters are recorded via the USB data logger as soon as data logging is started with the "Mode" parameter.
Note: Before you carry out this function, you must insert a USB stick with the "USB log Definition file" into the USB interface on the control board.

5.3.3 Settings and features in the "Features"

5.3.3.1 Accessing the "Features" submenu

Access the "Features" submenu as shown below.

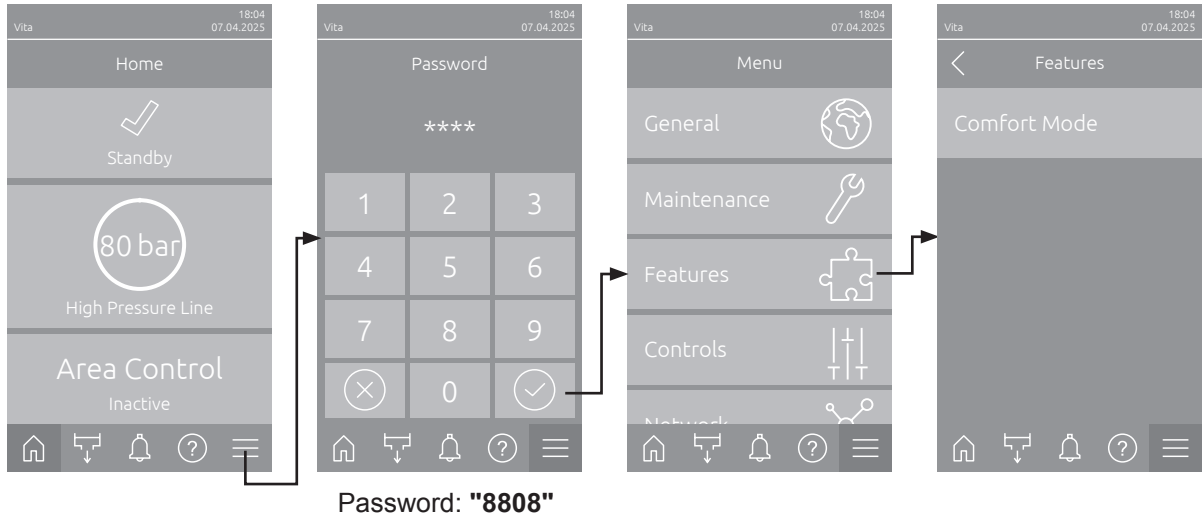

5.3.3.2 Defining the comfort mode time in the "Comfort Mode" submenu

During comfort mode the main line is not being flushed. This allows constant humidity during the defined time periods. The missing flushing time will be added and performed after the comfort time is over. To ensure that all flushing times can be completed within 24 hours, the specified comfort time is shortened if necessary.

However during comfort mode hygienic flushing of the individual zones will still be performed.

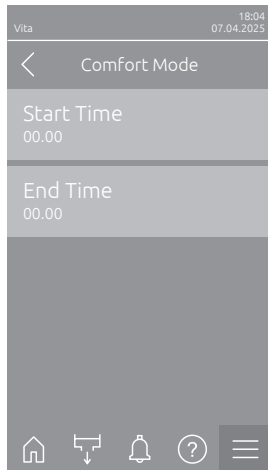

- **Start Time:** with this setting you define the start time of the comfort mode.
Factory setting: **00.00**
Setting range: **00.00 - 23.59**
- **End Time:** with this setting you define the end time of the comfort mode.
Factory setting: **00.00**
Setting range: **00.00 - 23.59**

Note: If both times are set to "00.00" the comfort time is deactivated.

5.3.4 Settings and features in the "Controls" submenu

In the "Controls" submenu you determine the control settings for the Condair Vita Power pure water system. The control settings available depend on the selected signal source and the control mode.

5.3.4.1 Accessing the "Controls" submenu

Access the "Controls" submenu as shown below.

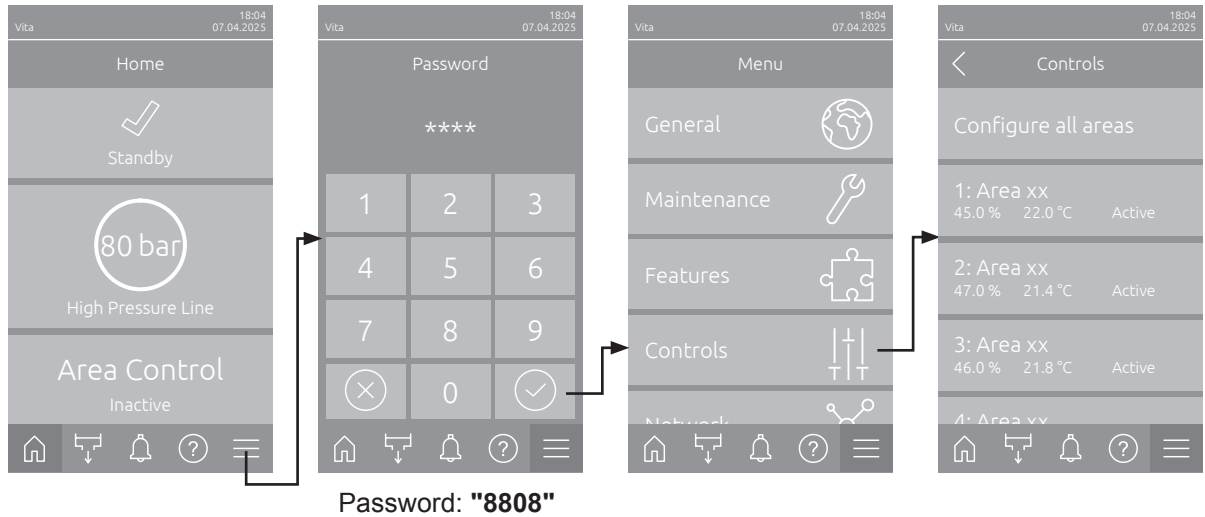

5.3.4.2 Control settings in the "Configure all areas" submenu

The settings in the "Configure all areas" submenu apply for all areas unless areas have been set individually (see [Section 5.3.4.3](#)).

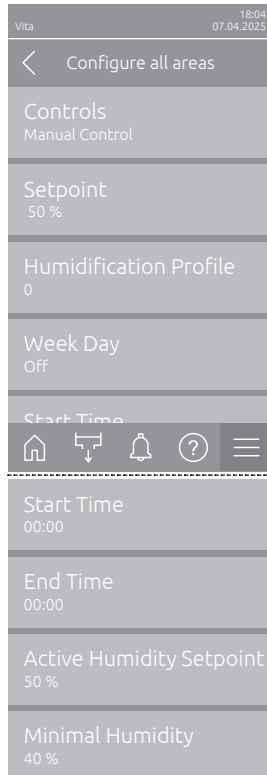

- **Controls:** With this setting you determine the control mode applied to all areas.
 Factory setting: **Off**
 Options: **Manual Control** (regulation based on setpoint value)
Auto-Low (automatic comfort regulation with low humidity)
Auto-High (automatic comfort regulation with increased humidity)
Off (regulation of all areas is turned off, only regular hygienic flushing is performed)
- **Setpoint:** with this setting you determine the humidity setpoint in %rh applied to all areas.
 Factory setting: **50 %rh**
 Setting range: **20 ... 100 %rh**
- **Humidification Profile:** With this setting you select the desired humidification profile to be applied to all areas.
Attention: The assignment of a humidification profile may only be done in consultation with Condair.
 Factory setting: **0 (no humidification profile applied)**
 Setting range: **0 ... 5**
- **Week Day:** with this setting you determine the weekday or weekday range when the automatic humidity control should be activated.
 Factory setting: **Off**
 Options: **Off, Mon, Tue, Wed, Thu, Fri, Sat, Sun, Mon-Fri, Sat-Sun, Mon-Sun**
- **Start Time:** with this setting you determine the start time when the automatic humidity control should be activated on the selected weekday or weekday range.
 Factory setting: **00:00**
 Setting range: **00:00 ... 23:59**
- **End Time:** with this setting you determine the end time when the automatic humidity control should be deactivated on the selected weekday or weekday range.
 Factory setting: **00:00**
 Options: **00:00 ... 23.59**
- **Active Humidity Setpoint:** with this setting you determine the target humidity when automatic humidity control is active.
 Factory setting: **50 %**
 Setting range: **50 ... 80 %**
- **Minimal Humidity:** With this setting you determine target humidity when automatic humidity control is off.
 Factory setting: **40 %**
 Setting range: **20 ... 60 %**

5.3.4.3 Control settings in the "Areas xx" submenus

Each activated area can be defined with individual control settings using in the settings in the "Areas xx" submenus.

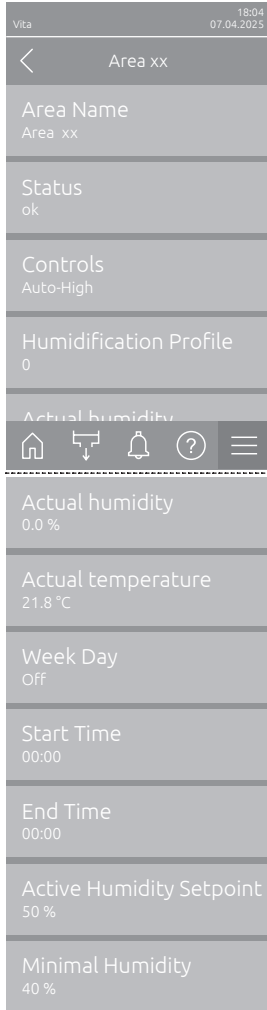

- **Area Name:** With this setting you can determine an individual name for the selected area.
Factory setting: **Area xx**
- **Status:** Shows the actual status of the selected area.
- **Controls:** With this setting you determine the control mode for the selected area.
Factory setting: **Off**
Options: **Manual** (regulation based on setpoint value)
Auto-Low (automatic comfort regulation with low humidity)
Auto-High (automatic comfort regulation with increased humidity)
Off (regulation of the corresponding area is turned off, only regular hygienic flushing is performed)
- **Humidification Profile:** With this setting you select the desired humidification profile to be applied to the selected area.
Attention: The assignment of a humidification profile may only be done in consultation with Condair.
Factory setting: **0 (no humidification profile applied)**
Setting range: **0 ... 5**
- **Actual humidity:** Shows the actual humidity in %rh of the selected area.
- **Actual temperature:** Shows the actual temperature in °C of the selected area.
- **Week Day:** with this setting you determine the weekday or weekday range when the automatic humidity control should be activated for the selected area.
Factory setting: **Off**
Options: **Off, Mon, Tue, Wed, Thu, Fri, Sat, Sun, Mon-Fri, Sat-Sun, Mon-Sun**
- **Start Time:** with this setting you determine the start time when the automatic humidity control should be activated on the selected weekday or weekday range for the selected area.
Factory setting: **00:00**
Setting range: **00:00 ... 23:59**
- **End Time:** with this setting you determine the end time when the automatic humidity control should be deactivated on the selected weekday or weekday range.
Factory setting: **00:00**
Options: **00:00 ... 23:59**

- **Active Humidity Setpoint:** with this setting you determine the target humidity when automatic humidity control is active.
 Factory setting: **50 %**
 Setting range: **50 ... 80 %**
- **Minimal Humidity:** With this setting you determine target humidity when automatic humidity control is off.
 Factory setting: **40 %**
 Setting range: **20 ... 60 %**

5.3.5 Communication settings in the "Network" submenu

In the "Network" submenu you determine the parameters for digital communication protocols.

5.3.5.1 Accessing the "Network" submenu

Access the "Network" submenu as shown below.

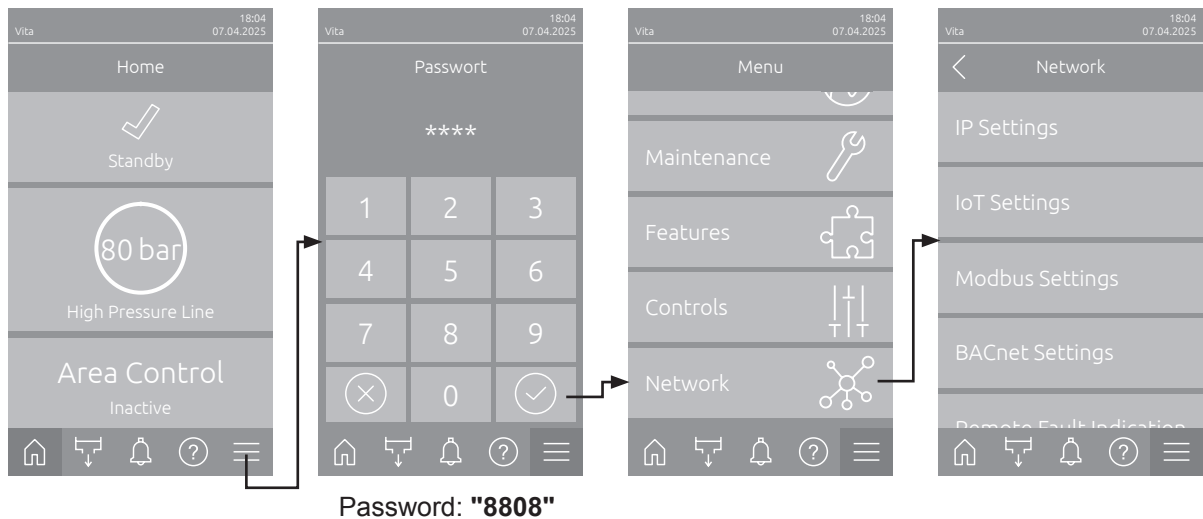

5.3.5.2 Settings in the "IP Settings" submenu

The following network settings are used only for the communication via the integrated BACnet IP, Modbus TCP or IoT interface.

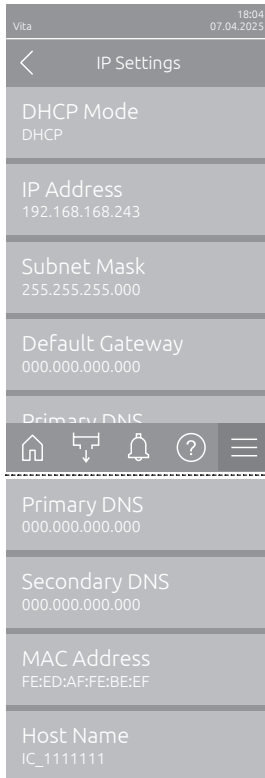

- **DHCP Mode:** with this setting you determine whether you want to assign the IP Address, the Subnet Mask, the Standard Gateway as well as the Primary and Secondary DNS address as fixed values or whether these should be dynamically assigned via a DHCP server.
Note: If no address can be assigned via a DHCP server when "DHCP Mode" is set to "DHCP", an APIPA (Automatic Private IP Addressing) is automatically assigned. This is in the range from 169.254.1.0 to 169.254.254.255. The subnet mask is set to 255.255.0.0 and the standard gateway remains 0.0.0.0.
Factory setting: **DHCP**
Options: **DHCP** (dynamic assignment)
Fixed (fixed assignment)
- **IP Address:** This field shows the actual IP address of Condair Vita Power assigned manually or assigned by a DHCP server.
If the parameter "DHCP Mode" is set to "Fixed", the IP address of Condair Vita Power can be set via this field. If the parameter "DHCP Mode" is set to "DHCP", the IP address of Condair Vita Power is assigned by a DHCP server.
- **Subnet Mask:** This field shows the actual subnet mask of the IP network assigned manually or assigned by a DHCP server.
If the parameter "DHCP Mode" is set to "Fixed", the subnet mask can be set via this field. If the parameter "DHCP Mode" is set to "DHCP", the subnet mask is assigned by a DHCP server.
- **Default Gateway:** This field shows the actual IP address of the default gateway assigned manually or assigned by a DHCP server.
If the parameter "DHCP Mode" is set to "Fixed", the IP address of the default gateway can be set via this field. If the parameter "DHCP Mode" is set to "DHCP", the IP address of the default gateway is assigned by a DHCP server.
- **Primary DNS:** This field shows the actual IP address of the primary domain name server (DNS) assigned manually or assigned by a DHCP server.
If the parameter "DHCP Mode" is set to "Fixed", the IP address of the primary domain name server can be set via this field. If the parameter "DHCP Mode" is set to "DHCP", the IP address of the primary domain name server is assigned by a DHCP server.
- **Secondary DNS:** This field shows the actual IP address of the secondary domain name server (DNS) assigned manually or assigned by a DHCP server.
If the parameter "DHCP Mode" is set to "Fixed", the IP address of the secondary domain name server can be set via this field. If the parameter "DHCP Mode" is set to "DHCP", the IP address of the secondary domain name server is assigned by a DHCP server.
- **MAC Address:** Factory set MAC Address (Media Access Control) of Condair Vita Power. Not modifiable.
- **Host Name:** Host Name of Condair Vita Power automatically generated by the control. Format: "IC_"+"Serial number of Condair Vita Power". Not modifiable.

5.3.5.3 Settings in the "IoT Settings" submenu

The following settings are only required for communication via IoT.

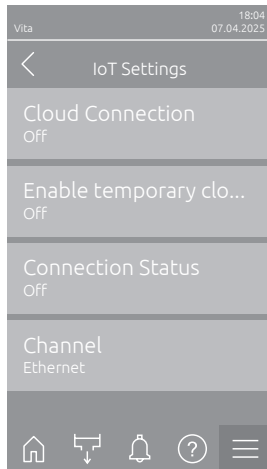

- **Cloud Connection:** With this function you can enable ("On") or disable ("Off") the connection to the cloud.
Note: If you press the button and the cloud connection is not yet activated, a confirmation window will appear in which you must confirm the IoT terms of use. Scanning the displayed QR code with your mobile device will take you to the IoT terms of use page. If you do not agree to the terms of use, pressing <Back> will return you to the IoT submenu, and the cloud connection will remain disabled.
Factory setting: **Off**
Options: **Off or On**
- **Enable temporary cloud write access:** This function allows you to turn temporary write access to your system via the cloud "on" oder "Off".
Factory setting: **Off**
Options: **Off or On**
- **Connections Status:** This function shows the current status of the cloud connection ("On" or "Off").
- **Channel:** With this function you determine the type of connection to the cloud (connection via Ethernet or connection via GSM).
Factory setting: **Ethernet**
Options: **Ethernet or GSM**

5.3.5.4 Settings in the "Modbus Settings" submenu

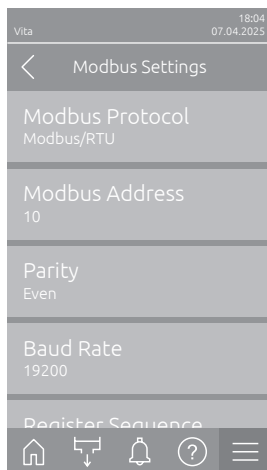

- **Modbus Protocol:** with this setting you can activate "**Modbus/RTU**" or "**Modbus/TCP**" communication via a Modbus network or deactivate ("Off") Modbus communication.
Factory setting: **Modbus/RTU**
Options: **Off, Modbus/RTU or Modbus/TCP**

Important: regarding the setting of the individual Modbus parameters as well as the wiring of the Condair Vita Power for the Modbus communication, please observe the instructions in the separate Modbus addendum manual. This manual can be requested from your Condair representative.

5.3.5.5 Settings in the "BACnet Settings" submenu

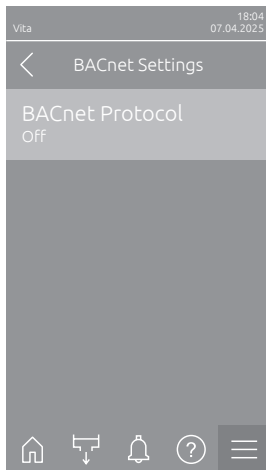

- **BACnet Protocol:** with this setting you can activate ("BACnet MS/TP" or "BACnet/IP") or deactivate ("Off") the communication via the integrated BACnet interfaces.

Factory setting: **Off**

Options: **Off** (BACnet interface deactivated)

MS/TP Master (BACnet MS/TP Master via RS 485 interface)

MS/TP Slave (BACnet MS/TP Slave via RS 485 interface)

BACnet/IP (BACnet/IP via RJ45 interface)

Important: regarding the setting of the individual BACnet parameters as well as the wiring of the Condair Vita Power for the BACnet IP or BACnet MS/TP communication, please observe the instructions in the separate BACnet addendum manual. This manual can be requested from your Condair representative.

6 Maintenance

6.1 Important notes on maintenance

Qualification of personnel

All maintenance work must be carried out only by well qualified and trained personnel authorised by the owner. It is the owner's responsibility to verify proper qualification of the personnel.

For VDI-certified systems, the personnel must meet the following qualifications:

- For general installation, maintenance and inspection work:
Completed training according to **VDI 6022 Sheet 6, Qualification category B**
- For hygiene-relevant work during planning, installation, commissioning, operation and maintenance as well as for hygiene inspections:
Completed training according to **VDI 6022 Sheet 6, Qualification category A**

General note

The instructions and details for maintenance work must be followed and upheld.

Only the maintenance work described in this documentation may be carried out.

Only use original Condair spare parts to replace faulty parts.

Safety



DANGER!
Risk of electric shock!

The Condair Vita Power is mains powered. Live parts may be exposed when components of the system are opened. Touching live parts may cause severe injury or danger to life.

Prevention: Before carrying out any work on the components of the **Condair Vita Power** take the system out of operation as described in [Section 4.6](#) and secure the system against inadvertent power-up.



WARNING!

Do not use oil, grease, glue, Teflon, silicone, O-ring lubrication, etc. when assembling pipe or hose connections. All of these products can lead to the growth of bacteria and thus pose health risks.

Only approved lubricant is: **Dishwashing liquid.**

When fitting water filters, hoses and other components in direct contact with water, wash your hands and wear sterile disposable gloves or touch only the packing foil to keep the filter and RO membranes bacteria-free.

Do not remove dust protection caps on pipe and hose ends until just before assembly.

6.2 Maintenance intervals

To maintain hygienic operation and operational safety, the Condair Vita Power pure water system must be maintained at regular intervals. The control software of the Condair Vita Power pure water system features different maintenance counters. The maintenance counters are set at the initial commissioning based on the water condition on site, however the maintenance counters can be adjusted at any time later to the actual operational conditions.

If one of the maintenance counters has elapsed, a maintenance message is triggered indicating that the corresponding maintenance must be carried out.

6.3 Maintenance list

Below you will find an overview of the maintenance work to be carried out and their intervals.

Component	Interval	Work to be done
Deionizing cartridge	When the maintenance message is displayed	Replace deionizing cartridge (see Section 6.4.2). Note: Only with Condair Vita Power RO-DI-CO-UV-HP Important: For uninterrupted operation, we recommend that you always have at least two new deionizing cartridges in stock.
CO ₂ pressure gas cylinder	When the maintenance message is displayed	Replace the CO ₂ compressed gas cylinder (see Section 6.4.3). Note: Only with Condair Vita Power RO-DI-CO-UV-HP Important: For uninterrupted operation, we recommend that you always have at least one full CO₂ compressed gas cylinder in stock.
Micro particle filter(s)	every six months (VDI certified systems every three month)	Replace micro particle filter(s) (see Section 6.4.4). Important: For uninterrupted operation, we recommend that you always have new microparticle filters in stock.

Important: VDI-certified systems must be inspected and maintained in accordance with the specifications in the VDI 6022 / Part 6 guidelines.

6.4 Maintenance work

6.4.1 Replacing the micro particle filter(s)

The replacement interval of the micro particle filter(s) is monitored by the controller. As soon as the micro particle filter(s) need(s) to be replaced, a corresponding message is issued (0x026D - Filter replacement is due).

For replacing the microparticle filter(s), please refer to the instructions in the separate manual supplied with the microparticle filter(s).

6.4.2 Replace deionizing cartridge

The controller monitors the capacity of the deionizing cartridges. Once they are exhausted, a corresponding message (0x0241 - Conductivity deionizing cartridge too high) is issued, indicating that the deionizing cartridges need to be replaced.

For replacing the deionizing cartridges, please refer to the instructions in the separate manual supplied with the deionizing cartridges.

6.4.3 Replacing the CO₂ compressed gas cylinder

The system monitors the minimum CO₂ pressure required for operation. If the pressure drops below this value, a corresponding message (0x0236 - CO₂ compressed gas cylinder empty) is issued, indicating that the CO₂ cylinder needs to be replaced.



DANGER!

Danger of suffocation due to inadequate ventilation

Ensure adequate ventilation during work on the CO₂ gas cylinder and observe all applicable local safety provisions when handling carbon dioxide and pressurised gas containers.



CAUTION!

Damage caused by leaking system

Once the system is back in operation, it is imperative that it be monitored for any leaks. Check the system occasionally over the next two days.



CAUTION!

Choosing the correct CO₂ compressed gas cylinder

The Condair Vita Power pure water system may be operated only with carbon dioxide type "UN 1013".

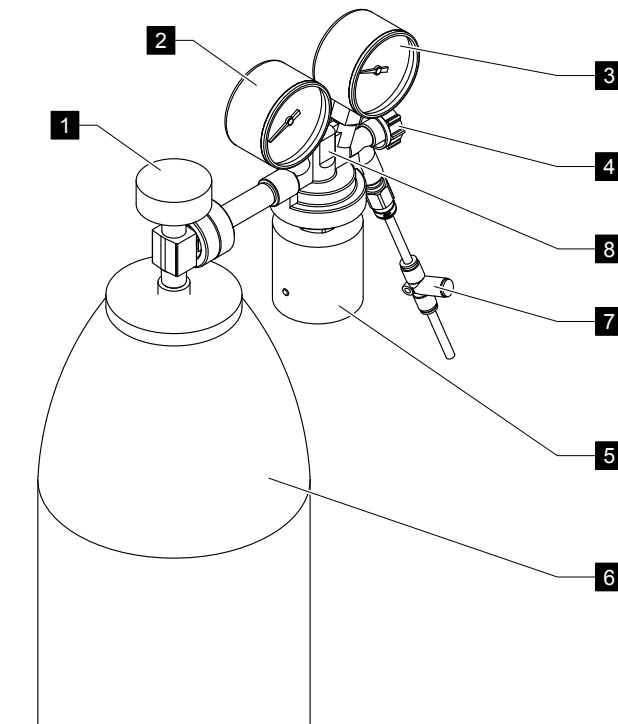

Fig. 7: Replacing the CO₂ compressed gas cylinder

Procedure:

- Turn the gas cylinder valve (1) on the gas cylinder clockwise.
- Operate the relief valve (7) until the residual pressure is released and both pressure gauges (3 and 4) show "0".
- Loosen and remove the cylinder pressure regulator (8) from the CO₂ gas cylinder (6) using a spanner or similar tool.

- Remove the old CO₂ compressed gas cylinder (6).
- Place the new CO₂ compressed gas cylinder (6) in the designated location and secure it.
- Make sure that the connections (cylinder valve and pressure regulator) are free of any grease, oil, glycerine and other lubricants and that the seals and seal surfaces are not damaged.
- With the cylinder valve closed, screw the cylinder pressure regulator (8) tightly onto the new CO₂ compressed gas cylinder using a spanner.
- Open the gas cylinder valve (1) slowly. The pressure is displayed on the pressure gauge (2).
- Check the working pressure on the pressure gauge (3). The working pressure should be 6 bar. If necessary, adjust the working pressure to 6 bar using the pressure setting valve (5).
- Open the shut-off valve (4) by turning it slowly. If there is a slight pressure drop, correct it on the pressure setting valve (5) to 6 bar.
- The system will restart itself.

Procedure in the event of possible errors:

If a CO₂ gas error persists after replacing the CO₂ compressed gas cylinder, carry out the steps listed below:

- Check the connections:
 - Check the hose connections between the compressed gas cylinder and container.
 - Check the working pressure setting.
 - Are the coupling connections correctly connected? When using a multi-coupler, it must be firmly seated without a gap between the upper and lower parts.
 - Restart the controller:
 - Open the main menu by pressing the <Menu> button on the external control unit and then entering the user password <8808>.
 - In the menu select "**Maintenance > Error & Warning > Error Reset**" in order to perform a soft reset.
- or
- Switch off the Condair Vita Power via the electrical isolator.
 - Wait 10 seconds, then switch the Condair Vita Power back on via the electrical isolator.

6.4.4 Performing software updates

To update the control software or the firmware of the control and driver boards, proceed as follows::

1. If the software update is to be performed **via an update file on a USB memory stick**: Carefully insert the FAT32-formatted USB flash drive containing the appropriate update program(s) into the USB port on the back of the external control unit. Ensure that the USB flash drive used is no longer than 75 mm.

Note: In order to successfully update the external control unit or System Master software, the valid update file(s) must be located at the top level outside of any folder on the USB memory stick. Otherwise, an error message will appear when attempting the update.

If the software update is to be performed using an update file transferred from Condair to the system: Ensure that the update file(s) have been transferred from Condair to your system. A corresponding message will appear in the event list.

Note: If no corresponding update file(s) have been transferred to your system or if they have been deleted by a reboot, an error message will appear when attempting the "Update from Remote" update function.

2. On the home screen, press the **<Menu>** button and then enter the password (8808).
3. Select the function "Update" (Path: "Menu > Password. 8808 > Maintenance > Update". See also [Section 5.3.2.5](#).
 - Select "Update from USB" if you want to update the external control unit control software using an update file on a USB memory stick.
 - Select "Update System Master from USB" if you want to update the System Master control software using an update file on a USB memory stick.
 - Select "Update from Remote" if you want to update the external control unit control software with an update file transferred to the system by Condair.
 - Select "Update System Master from Remote" if you want to update the System Master control software using an update file transferred to the system by Condair.
4. The software update confirmation screen appears. Press the **<Continue>** button.
5. When updating the control software of the external control unit via USB, an information window with details about the software update will appear after approximately one minute. Press the **<Reboot>** button to start the software update.

When updating the control software of the external control unit remotely or when updating the control software of the System Master (via USB or remotely), the software update will start automatically.

The update may take several minutes. During the update process, the screen of the control unit is inactive, and when the System Master is being updated, the LED on the control unit flashes blue. Once the process is complete, the home screen reappears.



CAUTION!

Do not interrupt a software update that is in progress. Wait until the update is complete. If a software update is inadvertently interrupted, the older software version will be automatically reinstalled, and the software update will need to be restarted.

6. Repeat the corresponding update function for all update files.

7 Fault elimination

7.1 Important notes on fault elimination

Qualification of personnel

Faults may only be remedied by qualified and trained personnel authorized by the owner.

General notes

All repair work on the Condair Vita Power may only be carried out by your Condair representative or by trained personnel from a Condair authorized service provider.

Only use original spare parts from your Condair representative to replace defective parts.

Safety



DANGER!
Risk of electric shock!

The Condair Vita Power is mains powered. Live parts may be exposed when components of the system are opened. Touching live parts may cause severe injury or danger to life.

Prevention: Before carrying out any work on the components of the **Condair Vita Power** take the system out of operation as described in [Section 4.6](#) and secure the system against inadvertent power-up.



CAUTION!

The electronic components inside the System Master are very sensitive to electrostatic discharge.

Prevention: Before carrying out any repair work to the electrical or electronic equipment of the control unit, appropriate measures must be taken to protect the respective components against damage caused by electrostatic discharge (ESD protection).

7.2 Fault indication

Malfunctions during operation detected by the control software are indicated by a corresponding **Warning** message (Status LED on the external control unit lights up yellow and the exclamation mark symbol is displayed in the device and error status field of the home screen) or **Error** message (Status LED lights up red and the cross symbol is displayed in the device and error status field of the home screen).

Warning

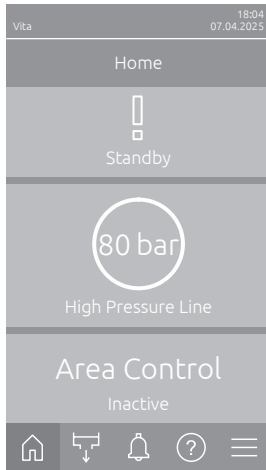

Temporary problems (e.g., water supply interrupted for a short time) or malfunctions which cannot cause damage to the system are indicated with a warning message, additionally the status LED lights up yellow. **If the cause of the malfunction disappears of its own accord within a certain period of time, the warning message will automatically switch off otherwise an error message is triggered.**

Note: Warnings can be indicated also via the service relay of the remote operating and fault indication. Therefore the warning indication via the service relay must be activated in the "Network" submenu of the control software (see [Section 5.1.1](#)).

Error

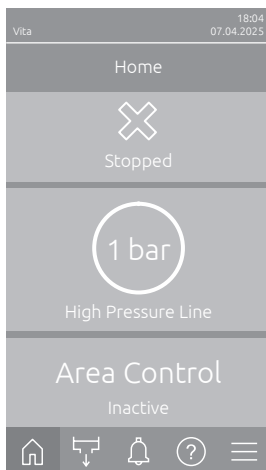

Malfunctions where further operation is not possible any longer or malfunctions which can damage the system are indicated with an error message, additionally the status LED lights up red. If such a malfunction occurs the operation of the system is limited only, or the system will be stopped automatically.

Note: The hygiene flushing will continue to be carried out if possible.

By pressing on the <Events> button in the home screen the error list shown with all active warning and error messages. By pressing on the corresponding Warning or Error entry additional information regarding the malfunction are displayed (see display on the far right).

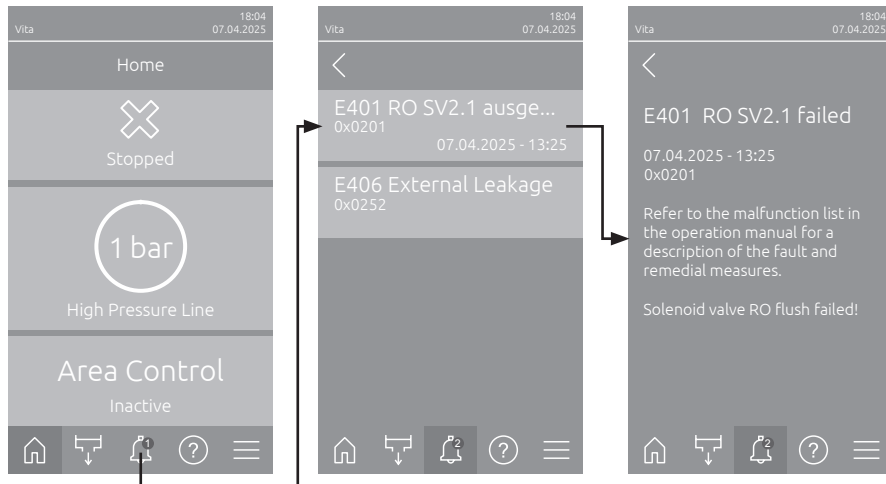

7.3 Malfunction lists

Most operational malfunctions are not caused by faulty equipment but rather by improper installation or disregard of planning guidelines. Therefore, a complete malfunction diagnosis always involves a thorough examination of the entire system (e.g., hose connections, humidity control system, etc.).

Note: Remedial measures highlighted in gray in the malfunction list may only be remedied by a Condair service technician or a service center authorized by Condair. If applicable, contact your Condair representative.

7.3.1 Malfunction list System Master

Code		Message	Information	
Warning	Fault		Possible causes	Remedy
Water treatment valve errors				
–	0x0200	RO SV1.1 failed	Valve or cable defective	Check the electrical connections and restart the system. Reset error where necessary. Contact your Condair representative.
–	0x0201	RO SV2.1 failed	Valve or cable defective	Check the electrical connections and restart the system. Reset error where necessary. Contact your Condair representative.
–	0x0202	UV-HP SV6.2 failed	Valve or cable defective	Check the electrical connections and restart the system. Reset error where necessary. Contact your Condair representative.
–	0x0203	UV-HP SV6.1 failed	Valve or cable defective	Check the electrical connections and restart the system. Reset error where necessary. Contact your Condair representative.

Code		Message	Information	
Warning	Fault		Possible causes	Remedy
–	0x0204	DI-CO2 SV4.1 failed	Valve or cable defective	Check the electrical connections and restart the system. Reset error where necessary. Contact your Condair representative.
–	0x0205	DI-CO2 SV4.2 failed	Valve or cable defective	Check the electrical connections and restart the system. Reset error where necessary. Contact your Condair representative.
–	0x0207	RO SV2.2 failed	Valve or cable defective	Check the electrical connections and restart the system. Reset error where necessary. Contact your Condair representative.
Water treatment actuator errors				
–	0x0210	RO pump motor failed	Defective Relay or Cable	Check the electrical connections and restart the system. Reset error where necessary. Contact your Condair representative.
0x0213	0x0214	UV lamp end of lifetime	UV–Lamp Bulb needs replacement	Replace the UV–Lamp bulb.
0x0215	0x0217	UV lamp failed	Defective UV–Lamp or Cable	Replace the UV–Lamp bulb. Check the electrical connections and restart the system. Reset error where necessary. Contact your Condair representative.
–	0x0219	UV-HP fan failed	Defective Fan or Cable	Check the electrical connections and restart the system. Reset error where necessary. Contact your Condair representative.
–	0x021A	Current reverse osmosis pump motor too high	Defective Motor	Check the electrical connections and restart the system. Reset error where necessary. Contact your Condair representative.
–	0x021B	Current high pressure pump motor too high	Defective Motor	Check the electrical connections and restart the system. Reset error where necessary. Contact your Condair representative.
–	0x021E	Current UV lamp too low	UV–Lamp Bulb broken or defective UV–Ballast or cable	Replace the UV–Lamp Bulb. Check the electrical connections and restart the system. Reset error where necessary. Contact your Condair representative.
–	0x021F	Current sensor UV lamp failed	UV–Ballast broken	Check the electrical connections and restart the system. Reset error where necessary. Contact your Condair representative.

Code		Message	Information	
Warning	Fault		Possible causes	Remedy
Water treatment sensor errors				
–	0x0222	RO PT1.2 pressure sensor failed	Defective sensor or cable	Check the electrical connections and restart the system.
				Reset error where necessary.
				Contact your Condair representative.
–	0x0223	RO PT2.1 pressure sensor failed	Defective sensor or cable	Check the electrical connections and restart the system.
				Reset error where necessary.
				Contact your Condair representative.
–	0x0224	UV-HP PT6.1 pressure sensor failed	Defective sensor or cable	Check the electrical connections and restart the system.
				Reset error where necessary.
				Contact your Condair representative.
–	0x0225	UV-HP PT6.2 pressure sensor failed	Defective sensor or cable	Check the electrical connections and restart the system.
				Reset error where necessary.
				Contact your Condair representative.
–	0x0226	UV-HP temperature sensor failed	Defective sensor or cable	Check the electrical connections and restart the system.
				Reset error where necessary.
				Contact your Condair representative.
–	0x0227	DI-CO2 CT4 conductivity transmitter failed	Defective sensor or cable	Check the electrical connections and restart the system.
				Reset error where necessary.
				Contact your Condair representative.
–	0x0228	DI-CO2 CT3 conductivity transmitter failed	Defective sensor or cable	Check the electrical connections and restart the system.
				Reset error where necessary.
				Contact your Condair representative.
–	0x022D	RO PT1.1 pressure sensor failed	Defective sensor or cable	Check the electrical connections and restart the system.
				Reset error where necessary.
				Contact your Condair representative.
–	0x022E	Distance sensor water softener failed	Defective sensor or cable	Check the electrical connections and restart the system.
				Reset error where necessary.
				Contact your Condair representative.

Code		Message	Information	
Warning	Fault		Possible causes	Remedy
Water treatment pressure errors				
0x0234	0x0231	Low pressure at RO inlet for too long	Water supply interrupted or Inflow pressure too low	Check water supply. Check whether the manual inlet valve is open. Check whether inlet reducer valve is set to 3.5 bar. Contact your Condair representative.
–	0x0232	RO pump pressure out of defined range		Contact your Condair representative.
–	0x0233	Overpressure RO tank		Contact your Condair representative.
0x0234	0x0235	Pressure at HP inlet too low	Insufficient product water produced (Tank level low) / DI-CO ₂ manual valve closed / Blocked water pipe / Quick coupling not connected correctly / Defective sensor.	Wait for reverse osmosis water to be produced. Check water supply. Check whether the manual DI-CO ₂ valve is open Contact your Condair representative.
–	0x0236	CO ₂ compressed gas cylinder empty	CO ₂ Gas pressure too low / CO ₂ Gas empty	Check the gas pressure of the CO ₂ cylinder. Replace the CO ₂ cylinder. Contact your Condair representative.
–	0x023A	Overpressure during sprayloop flushing		Contact your Condair representative.
–	0x023B	Pressure too high at sprayloop end	Unloader defective / Unloader wrongly adjusted	Contact your Condair representative.
–	0x023C	Pressure too high at inlet	Too high inlet pressure / inlet reducer valve wrongly set	Reduce inlet pressure to max. 4 bar. Contact your Condair representative.
Water treatment conductivity errors				
0x0240	0x0241	Conductivity after deionizing cartridge too high	Deionizing cartridge used up	Replace deionizing cartridge.
0x0242	0x0243	Water softener lack of salt	Little or no salt in the softener	Refill salt. Reset error where necessary. Contact your Condair representative.
–	0x0244	Conductivity after DI-CO ₂ stage too low	CO ₂ Gas pressure too low / CO ₂ Gas empty CO ₂ parameters incorrectly set	Contact your Condair representative. Contact your Condair representative.
Leakage errors				
–	0x0256	Min. pressure not reached in time	Leakage in high-pressure system section / Defective nebulizer / Defective drainage valve / Air in the system	Check system for leakages and repair if possible. Reset error where necessary. If this is not the case, Contact your Condair representative.
–	0x0258	External leakage	External leakage	Find and fix the leak(s).

Code		Message	Information	
Warning	Fault		Possible causes	Remedy
General water preparation errors				
–	0x0260	Pressure discharge RO timed out		Contact your Condair representative.
–	0x0261	Pressure discharge HP timed out		Contact your Condair representative.
–	0x0262	Deionizing cartridge replacement timed out	Deionizing cartridge not replaced in set time period.	Complete cartridge replacement.
–	0x0263	System stopped or powered off too long	System switched off for too long.	Contact your Condair representative.
–	0x0264	Defective RO pressure tank		Contact your Condair representative.
–	0x0266	Temperature too high	HP water temperature too high	Reduce supply water temperature.
–	0x026D	Filter replacement is due	Microparticle filters must be replaced.	Replace all microparticle filters by running the filter replacement wizard.
–	0x026E	Maintenance is due	Maintenance is due.	Contact your Condair representative.
General CAN or node errors				
–	0x0402	Node error	Area Wiring broken / ABT not installed	Check the electrical connections and restart the system. Contact your Condair representative.
–	0x0405	Wrong area node numbering	Error occurred by area node numbering	Restart the system Contact your Condair representative.
–	0x0406	Area node configuration error	Error occurred by area node configuration	Restart the system Contact your Condair representative.
–	0x0413	External voltage	HumPower or SprayLoopController external power missing	Check the electrical connections and restart the system.
0x041D	0x0414	Safety humidistat steady	Humidity is too high / Sensor contaminated / Limit set to too low	Check the electrical connections and restart the system.
–	0x0504	SAB: Missing driver board	SAB cable not connected or defective cable	Check the electrical connections and restart the system. Contact your Condair representative.
–	0x0???	Unspecific error has occurred		Contact your Condair representative.

7.3.2 Malfunction list external control unit

Code		Message	Information	
Warning	Fault		Possible causes	Remedy
W1	—	Smartcard	No communication with Smartcard.	
			No Smartcard installed.	Contact your Condair representative.
			Smartcard not valid or defective.	
W6	E6	Main Missing	No communication between System Master and external control unit.	
			Connection cable between main unit and extension unit interrupted.	Contact your Condair representative.
W35	E35	Signal Timeout	The network (Modbus, BACnet, LonWorks) has stopped sending humidity/demand updates.	
			Signal cable from BMS not connected correctly or defective.	Contact your Condair representative.
			Interfering signal present.	
			Address conflict with other units in the chain.	Correctly set unit addresses.
W157	—	Software download from USB failed	Software download from USB failed.	
			Connection aborted during software download from USB stick or faulty update file.	Contact your Condair representative.
W158	—	Software download from Cloud failed	Software download from Cloud failed.	
			Connection aborted during software download from Cloud or faulty update file.	Contact your Condair representative.
—	E162	Software update failed	Software update failed.	
			Integrated controller switched off during update process or invalid software version downloaded.	Contact your Condair representative.

7.4 Resetting malfunction indication

To reset the malfunction indication, proceed as follows:

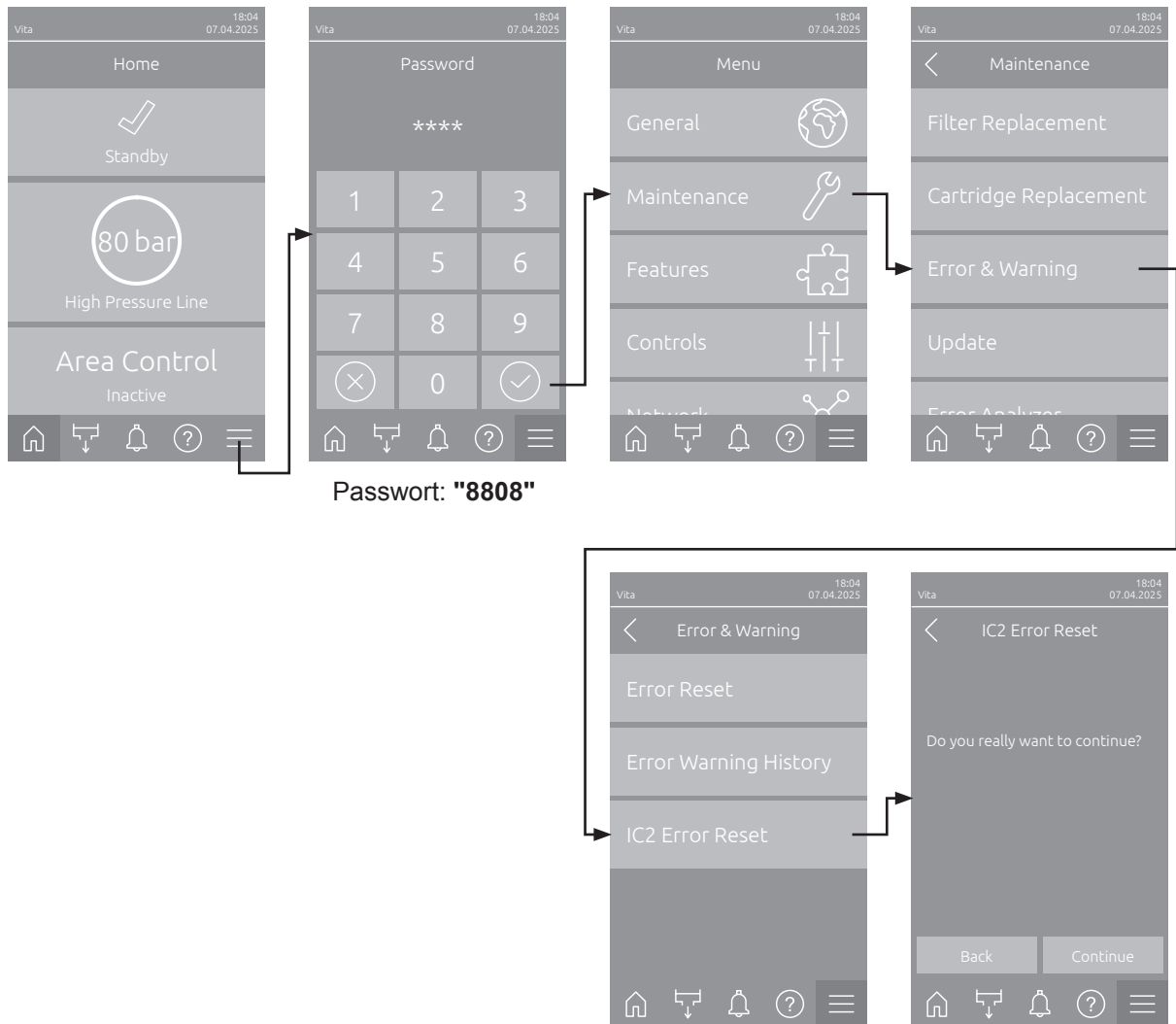

1. Select in the "Error Reset" (for System Master error) or "IC2 Error Reset" (for IC2 errors) function (Path: "Menu > Password: 8808 > Maintenance > Error&Warning > Error Reset/IC2 Error Reset").
2. The reset confirmation dialog appears:
 - Press the **<Continue>** button to reset the malfunction indication(s).
 - Press the **<Back>** button to abort the reset procedure. The control unit returns to the "Error&Warning" submenu.

If the malfunction indication cannot be reset via the control software (e.g., the display hangs), proceed as follows to reset the malfunction indication(s):

1. Switch off the Condair Vita Power via the electrical isolator.
2. Wait 10 seconds, then switch the Condair Vita Power back on via the electrical isolator.

Note: If the cause of the malfunction(s) has/have not been eliminated, the malfunction indication(s) reappear(s) after a short while.

Notes

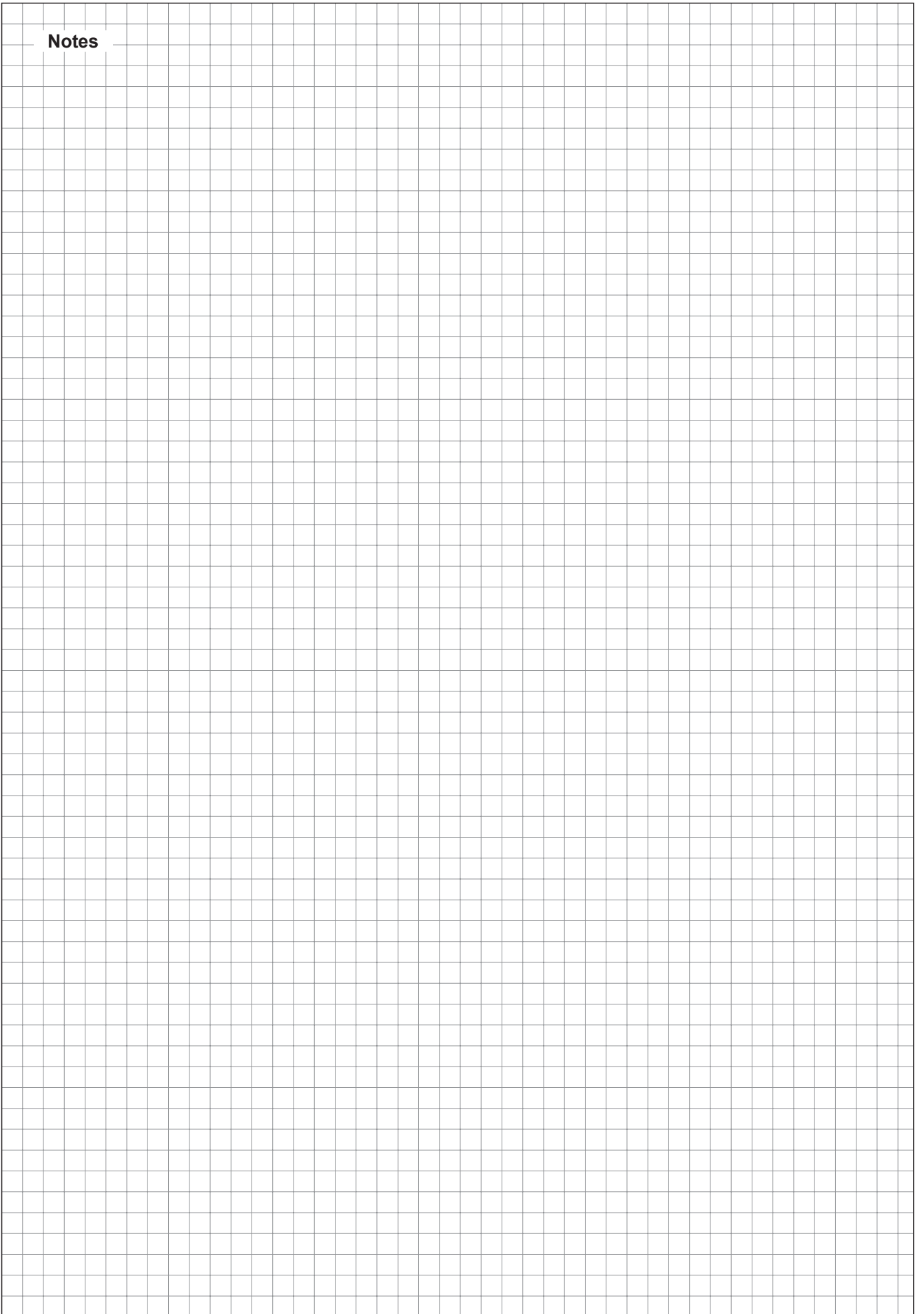

Notes

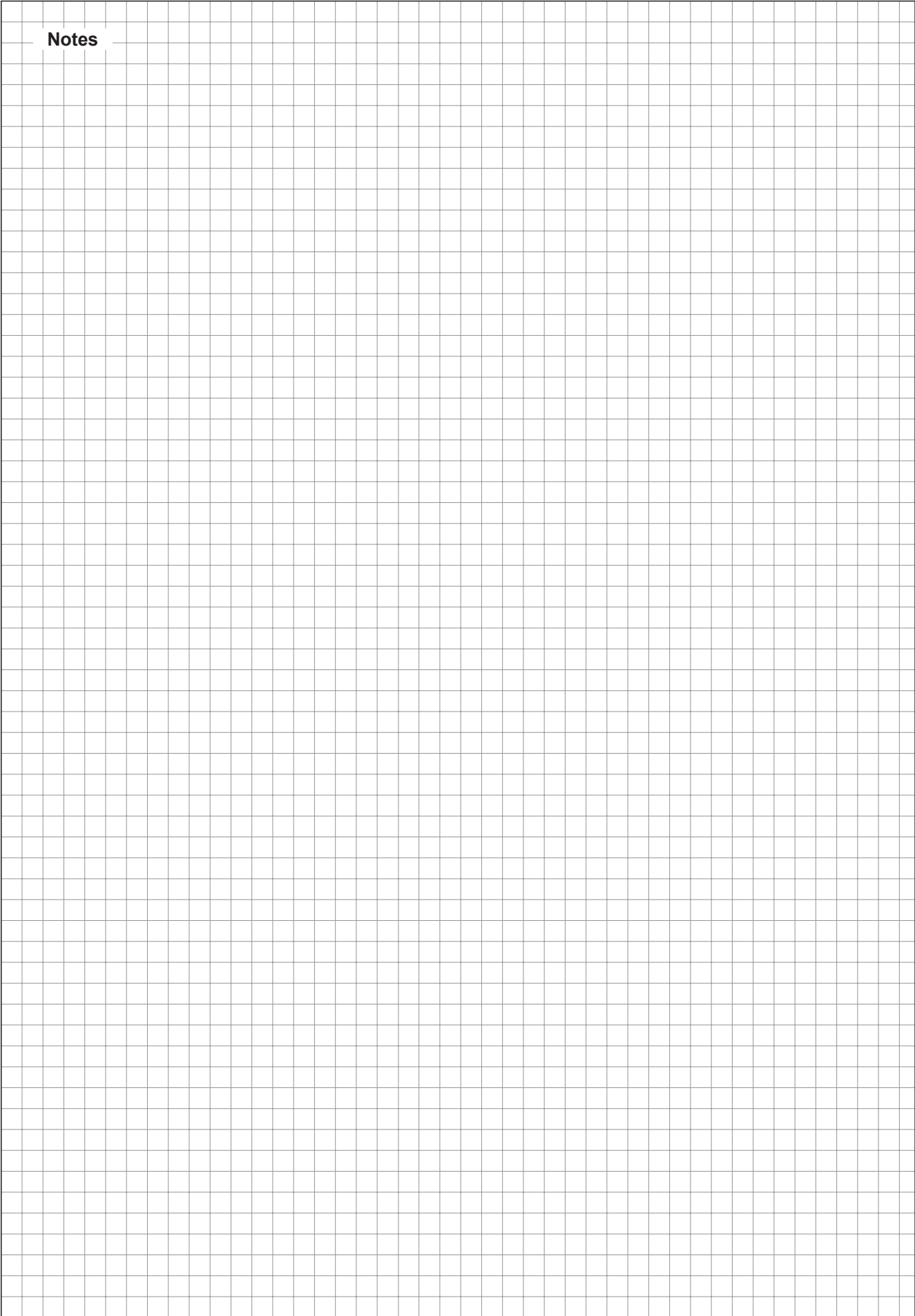

CONSULTING, SALES AND SERVICE:



CH94/0002.00

Condair Group AG
Gwattstrasse 17, 8808 Pfäffikon SZ, Switzerland
Phone +41 55 416 61 11, Fax +41 55 588 00 07
info@condair.com, www.condairgroup.com

 **condair**